



**WOLFSON UNIT
FOR MARINE TECHNOLOGY &
INDUSTRIAL AERODYNAMICS**

Report No. 2900_Rev10**Date : December 2023****Compiled By : MS****Verified By : MP****Southampton Marine and Maritime Institute****Evidencing a Seastate Allowance for Inshore Fishing Vessels by Model Scale Testing
Phase I****EXECUTIVE SUMMARY**

This report describes a programme of model scale tests of a 10 metre fishing vessel monohull design. The test vessel, a double chine steel potter of typical proportions, was tested at two configurations – decked vessel and open boat – over a range of loading conditions representing fishing operations. The tests were conducted in the 138 metre Boldrewood Towing Tank at the University of Southampton.

This work supports an ongoing project of the National Federation of Fishermen's Organisations (NFFO) and the objectives are twofold:

- establish whether the decked vessel configuration is sufficiently safe from capsizing in waves when operated within a seastate orientated allowance, as defined by the Wolfson Stability Method.
- determine the survivability in waves and, therefore, the relative safety from capsizing of the vessel at two configurations: decked and open.

The test vessel was selected in discussion with the Marine Accident Investigation Branch (MAIB) and the data available to the Wolfson Unit included a 3d definition of the hull and the vessel's stability history.

A 1:6 scale physical model was built and load conditions were identified whereby the decked vessel would fail a statutory stability assessment but, according to the Wolfson Method, could still be operated safely in benign seastates. Physical testing at these conditions confirms the merit of a seastate-based allowance, since all capsize events occurred at combinations of stability and wave height deemed unsafe by the Wolfson Method.

The decked model was then re-configured as an open boat by blocking up its freeing ports, installing a deck drainage system designed to the current MCA Code of Practice (CoP) and fitting a bilge pump of the appropriate capacity. The open boat model was then tested in the same conditions as the decked vessel.

Both the decked and the open vessel configuration capsized in short, steep regular waves approximately 1.1-1.2m in height. In a near-accident condition, the decked model also capsized within the wave height range 1.3 – 3.0m whereas the open model survived.

At the MCA minimum rating of 190 litres per minute, the bilge pump appeared adequate to disperse the excess flood water and therefore prevent a capsize. However, in a scenario with a malfunctioning bilge pump, the number of capsize events could potentially rise from 2 to 8 out of the 31 open boat runs performed.

It is recommended to evaluate the merit of fitting non-return flaps to the freeing ports of existing low-freeboard fishing boats, to consider replacing the CoP distance-based restrictions with seastate-based guidance according to the Wolfson Method, and to permit decked monohulls similar to the test vessel to demonstrate CoP compliance via alternative routes, as opposed to encourage their conversion to open boats.

1 INTRODUCTION

This report describes Phase I of a study to provide the NFFO with experimental evidence on the survivability in waves of a typical 10 metre fishing vessel at two configurations, decked vessel and open boat, in relation to stability criteria and guidance presented in the current MCA Code of Practice. The HEIF-RCSF grant funding that underpins this work was awarded by the Southampton Marine and Maritime Institute (SMMI) on 20th January, 2023 following proposal ref. 5358ms-wd_Rev2 of 18th November, 2022.

This study was conducted by the Wolfson Unit in partnership with NFFO and Public Policy | Southampton (PPS), with the MCA acting as independent observers.

2 BACKGROUND

Commercial fishing remains the most dangerous peacetime occupation worldwide. The death rate in developed countries exceeds 100 fatalities per 100,000 active fishers and is likely to be even higher in developing countries, where no formal accident reporting systems are in place [2].

Small fishing vessels undertake low-impact, environmentally sustainable fishing activities, catching high quality fresh fish daily, often with the owner and family members as fishing crews [3]. These boats, however, are the most vulnerable to accidents at sea due to their size relative to the sea state and are the most likely to capsize due to insufficient stability.

The UK small-scale fishing fleet consists of 4700+ boats under 15m that is, 90% of the commercial fishing fleet.

3 RATIONALE

The new Code of Practice (CoP) for the Safety of Small Fishing Vessels of less than 15m Length Overall [4], that came into effect on 6/9/2021, is an unprecedented effort to improve safety within the small-scale fishing industry and aims at reducing the rate of fatal fishing incidents in the UK. Whilst the CoP applies to the entire under 15m fishing fleet, vessels that pre-date the new standard were not designed with it in mind and, therefore, may not fully align with the new requirements.

The CoP has a two year phase-in period ending 6/9/2023, but there are no transitional arrangements for stability. Vessels which fail to comply with the new stability requirements may not operate commercially until they demonstrate compliance, or equivalence with recognised stability criteria.

Paragraph 3.12.4 of the new CoP applies to all *existing* vessels (ie registered for the first time as a Fishing Vessel before 16/7/2007) and states:

3.12.4 Decked Vessels with freeboard less than 300 mm are to be limited in their area of operation to 20 miles from a safe haven and in favourable weather conditions. The minimum freeboard should be at least 200 mm. Vessels with less than 200 mm Freeboard are to be considered Open Vessels³.

Paragraph 3.12.4 above refers to footnote 3, which states:

(³) Where the freeboard is less than the minimum freeboard indicated, where equivalence can be demonstrated the MCA may accept alternative arrangements.

Paragraph 11.1 of Marine Guidance Note (MGN) 503F Amt.1 [5] enables conditional certification, ie:

11.1 As a result of the stability tests, assessment of freeboard and / or water-freeing arrangements, the attending surveyor will take into consideration the Wolfson Stability Notice and may propose that

conditions be placed on the fishing vessel certificate. The intention of these conditions is to allow the vessel to operate in a controlled manner within a geographical / distance from safe haven / weather orientated allowance.

If equivalence cannot be demonstrated and conditional certification is not offered, then low freeboard decked vessels may either cease commercial operation or be converted to open vessels as stated in MCA guidance [6] below:

6. Freeboard (..) Vessels with less than 200mm freeboard may submit proposals to be considered for equivalence with vessels with 200mm freeboard or over. Vessels which do not achieve equivalence will be considered open vessels and the owner will need to bring the vessel in line with the open vessel standards, including water freeing arrangements.

Decked vessels may be converted to open boats by blocking up the freeing ports and installing alternative arrangements for dispersing flood water, such as electric and/or manually operated bilge pumps, depending on the vessel's size. In particular, the CoP open vessel requirements include:

2.19.4.1 There should be effective drain openings fitted on each side of the sole deck to enable any water to drain directly to the bottom of the Vessel. In the case of a Vessel with a sealed sole deck, an aft sump is to be fitted, extending from the keel to deck; potters and creel boats may have a sump located adjacent to the hauler position.

2.19.4.2 The drainage area should be at least 2% of the total bulwark area above the sole;

2.19.4.3 Open Vessels are not to be fitted with freeing ports;

The level of safety associated with the seastate based certification and the conversion of *existing* decked vessels to open boats are ongoing concerns for the inshore fishing industry and require evidencing.

4 PROGRAMME OF WORK

4.1 Work package 1 – selection of a test vessel

Several low-freeboard, decked fishing vessel designs under 15m overall length were shortlisted for the tests and a final design was selected in discussion with the Marine Accident Investigation Branch (MAIB). The data available for the test vessel include: a table of offsets of the hull to the top of the gunwale, general arrangement, tank definitions and capacity tables, inclining experiment results, two lightship conditions (as-built and modified, following the vessel's re-purposing) and a comprehensive stability assessment over a range of loading conditions representing typical fishing operations.

Table 1 presents the vessel's principal dimensions, alongside the datums and coordinate system used in this report.

4.2 Work package 2 – digital stability modelling of the decked vessel configuration

The WP1 data were processed to produce a digital stability model in the Wolfson hydrostatics and stability suite (HST). Subsequently, the model was successfully validated against the original hydrostatics following the Wolfson Unit's standard procedure and quality assurance criteria. The validated hull definition enabled a full stability analysis including assessment against the appropriate stability requirements, in accordance with [4] and [5].

Figures 1 and 2 present the HST hull definition.

The WP2 results are given in Section 5 and discussed in Section 6.

4.3 Work package 3 – survivability tests at model scale, decked vessel configuration

A 1:6 scale model of the vessel was constructed of wood and GRP in accordance with the WP2 data. The model was designated as Wolfson Unit model M1203 and incorporated a cambered main deck and a cambered foredeck, both fitted with hatches for ballasting purposes, a ballasting rig above deck to enable large changes in the vessel’s centre of gravity position and a fixed bulwark fitted with rectangular freeing ports.

The survivability tests in waves were conducted in the Boldrewood Towing Tank, University of Southampton. The tank is 145m long, by 6m wide, by 3.5m deep and is fitted with a wavemaker capable of producing full scale regular waves up to 4.2 metres high at a full scale period of 5.8 seconds.

Table 2 describes the water freeing arrangements of the decked vessel, which are at the minimum MCA requirement. Figure 3 shows the decked vessel in the Boldrewood Tank.

The WP3 test technique and results are given in Section 7 and discussed in Section 8.

4.4 Work package 4 – survivability tests at model scale, open boat configuration

The WP3 decked vessel model was converted to an ‘equivalent’ open boat by blocking up the freeing ports and fitting a bespoke, 3d printed drainage arrangement. Such an arrangement, typically referred to as ‘sump and pump’, consisted of a deck opening on each side of the vessel’s centreline at the lowest point of the sheer, leading to a centreline containment tank fitted with a remotely controlled bilge pump.

The CoP bilge pumping requirements for *existing* open vessels are:

4.10.4 (Existing Vessels) Where standards do not exist the bilge pumping arrangements must be fit for purpose.

It is understood from the MCA that Marine Guidance Note 628 (M+F) ‘Construction and outfit standards for fishing vessels of less than 15m length overall’ Part 9 ‘Pumping and piping systems’ is typically used for assessing the fitness for purpose of the bilge pumping arrangements of *existing* open vessels not built to a construction standard. In particular, paragraph 9.3.2 of MGN 628 requires vessels of 10 to 15m to install two bilge pumps (one manual, one electrical) having a minimum combined capacity of 190 litres/minute.

The bilge pump installed in the model was calibrated in-situ over a range of static heads and was operated at the minimum MCA requirement of 190 litres/minute throughout the tests.

Table 3 describes the water freeing arrangements of the open boat configuration. Figures 4 and 5 show the model in the open boat configuration and the bilge pump installation, with the main deck hatch temporarily removed.

The WP4 test technique and results are given in Section 9 and discussed in Section 10.

5 WP2 DIGITAL STABILITY MODELLING OF DECKED VESSEL: RESULTS

The resulting data are shown in the following tables:-

Table 4	Decked Vessel Stability Notice and Freeboard Guidance Mark
Table 5	Undecked Vessel Stability Notice and Freeboard Guidance Mark

Table 6	Loading Conditions and Configurations
Table 7	Summary of Stability and Maximum KG Criteria

The full stability results are presented in Appendix 1.

6 WP2 DIGITAL STABILITY MODEL OF DECKED VESSEL: DISCUSSION

- a. Loading conditions TEST 0 to 4 of Table 6 were assessed against the CoP criteria of para. 3.5. Pre-2007, unmodified vessels are not required to carry approved stability information and therefore need not meet such criteria. However, pre-2007 vessels that carry out modifications, alterations or change fishing method are treated as new vessels (CoP para 3.12.7) and may choose to be assessed against the CoP criteria in order to demonstrate suitable stability characteristics.
- b. TEST 0, the as-built port departure condition, met all the CoP stability criteria and exceeded the minimum freeboard requirement by more than 30%. Subsequent modifications eroded the vessel's stability reserves, resulting in partial compliance at TEST 1-2 and no compliance at TEST 3-4. TEST 3 is a top-heavy operating condition and TEST 4 is a near-accident condition.
- c. The Wolfson Stability Method indicates that the test vessel in the decked configuration can safely operate in the amber zone at port departure (TEST 0, 1) and at port arrival (TEST 2.1 and 3.1), but is at risk of capsize in the overloaded port arrival condition TEST 4.1. For the test vessel, the maximum recommended Hs in the amber zone is 1.3m that is, low end of Douglas 4 'Moderate'.
- d. TEST 0, 1, 2.1 and 3.1, however, are upright conditions. Lifts over the side, transverse shifts in catch/gear or gear snags resulting in 5° heel or more would reduce the residual freeboard to an unsafe level and the Wolfson method predicts that the vessel would be in danger of capsizing in sea states exceeding Hs = 0.6m that is, low end of Douglas 3 'Slight' at the heeled conditions tested.

7 WP3 DECKED VESSEL SURVIVABILITY: TEST TECHNIQUE AND RESULTS

The model was ballasted to the TEST 1 condition, at 13.54t displacement, -4.814m LCG and an inclining in air was performed to adjust its VCG to 1.391m. The pitch gyradius was set to 25% overall length and the roll gyradius to 33% overall beam. Colour-coded vertical bands were painted on each side of the model at two locations (25% overall length and midships) to identify the Wolfson Guidance Mark and associated safety zones.

The model was tested over a range of loading conditions, wave heights and periods following the test protocol described in [7]. In preparation to each run, the onboard ballast was adjusted to achieve the desired loading condition and direct measurements were made of the static heel and trim angles using a digital inclinometer with 0.01 degree accuracy, to ensure consistency with the calculated heel and trim of Table 7. The model was then positioned on the towing tank centreline and approximately 20 metres from the wavemaker.

The model heading was controlled manually with light lines fore and aft to enable a continuous rotation over the appropriate range of headings within each run. Each run comprised a continuous 180° rotation from 0° heading ie bow towards the incoming waves to 180° heading ie stern towards the waves. In addition, if the model had an initial list, it was tested at additional headings with the low side towards and away from the incoming waves to ascertain the most vulnerable side.

All the physical tests presented in this report were conducted in regular waves. This approach enables to correlate the minimum wave height to capsize the model (as measured in the towing tank with a wave probe) with the full scale sea state where it is probable to encounter such a 'critical' wave at least once during a typical

inshore fishing trip. For example, formulae given in [8] indicate that approximately 1 in 2000 waves within a typical seastate (Rayleigh distributed spectrum) will be twice the significant height. The reader is referred to [7] for a full discussion on this subject.

The resulting data are shown in the following figures:–

- Figure 6 Regular waves measured at loading conditions tested
- Figure 7 Capsize boundary for configuration ID 2.x, full scale data
- Figure 8 Capsize boundary for configuration ID 4.x, full scale data
- Figure 9 Relationship between the condition tested and the Wolfson safety zones
- Figure 10 Comparison of predicted critical seastates and actual capsize wave heights
- Figure 11 Variation of Minimum Wave Height to Capsize / LOA with Stability

8 WP3 DECKED VESSEL SURVIVABILITY: DISCUSSION

- a. The 6 load conditions tested resulted in 3 being capsized and 3 surviving. 7 capsize events in total were observed and the capsize mechanism appeared to be consistent across all these events.
- b. The 3 capsized conditions exhibited an initial list of 5° or more. The model consistently capsized whilst beam on and listing towards the incoming waves ie ‘to windward’. The capsize mechanism entailed rolling of the model to large windward angles, causing immersion of the windward freeing ports and resulting in the accumulation of water on deck. The net amount of water on deck increased over time, either progressively through the freeing ports or suddenly over the gunwale, until the model capsized to windward.
- c. 5 out of 7 capsizes occurred at condition 4.2 where a systematic variation of wave height and period was performed within the wave envelope permitted by the wave maker. The capsize boundary for condition 4.2 is given in Figure 8b and indicates that steeper waves increase the risk of capsizing.
- d. When the test vessel has less than 210mm residual freeboard, the Wolfson Guidance recommends a maximum seastate of 0.6m significant wave height, corresponding to a maximum wave height of approximately 1.2m (1 in 2000 waves, see Section 7). The minimum wave height to capsize of Figures 7c and 8b are within 13% of this prediction, which is in keeping with the general level of approximation provided the Guidance.
- e. Figure 8c shows that, on one occasion, the model capsized well below the predicted critical wave height. It is worth noting, however, that this capsize occurred at a near-accident condition (TEST 4.3) where the vessel was overloaded and had 9° of list, resulting in a minimum freeboard of minus 100mm (that is, deck edge underwater), a positive range of stability of just 7 degrees and a maximum righting moment of only 90 kg.m. At this loading condition, the stability reserves are small and the vessel may easily capsize in calm conditions due to small transverse weight shifts (eg crew, gear or catch). The assessment of such marginal conditions is outside the scope of the Guidance, which was devised based on the residual stability of vessels with positive freeboards only.
- f. The type of plot shown in Figure 11 was first presented in [7] and has subsequently been updated to include additional vessel casualties up to 2011 [9, 10]. The solid diagonal line represents the minimum wave height to capsize a vessel with known residual stability characteristics, according to the Wolfson Method. Combinations of stability and seastate below the line represent operating conditions where the vessel is deemed safe from capsizing, whereas the zone above the line indicates danger of capsizing. Figure 11 was used to summarize the outcome of the survivability tests conducted on the decked vessel and presented in this report. All the combinations of stability (calculated) and seastate (measured) resulting in a capsize lie on or above the line, which confirms the validity of the Wolfson Method for the hull form tested.

9 WP4 OPEN BOAT SURVIVABILITY: TEST TECHNIQUE AND RESULTS

The decked vessel test programme of Section 7 was repeated with the model in the open boat configuration and the same test technique was used. The tests were conducted at a constant bilge pump capacity of 190 litres per minute, which is the minimum MCA requirement stated in MGN 628(M+F), as discussed in Section 4.4.

At the near-accident condition 4.3, the decked vessel at equilibrium in calm water had water on deck due to the immersion of its freeing ports. When ballasted to condition 4.3, the open boat model had a dry deck as the freeing ports were blocked up, so it exhibited no free surface effects and no VCG increase due to the water on deck, resulting in better overall stability. Therefore, no survivability tests were conducted on the open boat model at condition 4.3, as the different initial stability would prevent a direct comparison with the decked vessel results.

The resulting data are shown in the following figures:-

- Figure 6 Regular waves measured at loading conditions tested
- Figure 7a to c Capsize boundary for configuration ID 2.x, full scale data
- Figure 8a to c Capsize boundary for configuration ID 4.x, full scale data

Finally, a simple numerical study was conducted in two water draining modes and the resulting GZ curves are shown in the following figures:

- Figure 12 Open boat variant: Righting lever (GZ) curves in 'sump & pump' mode
- Figure 13 Open boat variant: Righting lever (GZ) curves in 'free draining to bilge' mode
- Figure 14 Open boat variant: Righting lever (GZ) curves with 1.15 t flood water
- Figure 15 Open boat variant: Righting lever (GZ) curves with 1.65 t flood water
- Figure 16 Open boat variant: Righting lever (GZ) curves with 2.15 t flood water
- Figure 17 Open boat variant: Righting lever (GZ) curves with 2.65 t flood water

10 WP4 OPEN BOAT SURVIVABILITY: DISCUSSION

- a. The 5 load conditions tested resulted in 2 being capsized (nos. 2.3 and 4.1, same as the decked vessel) and 3 surviving. 2 capsize events in total were achieved and the capsize mechanism appeared to be consistent across these events. The 2 capsized conditions exhibited an initial list of more than 5°.
- b. Similarly to the decked vessel, the open boat capsized in short, steep regular waves approximately 1.1-1.2 metres in height. However, the capsize mechanism of the open boat was different, as it was initiated by a single wave hitting the side of the vessel while upright and beam on to the waves, Figures 18 – 19. Such a wave deposited a large amount of water on deck, which overwhelmed the bilge pump resulting in increased windward heel, reduced freeboard and therefore greater vulnerability to swamping by subsequent waves.
- c. When tested at load condition 2.3, both the decked vessel and the open boat capsized at approximately the same combination of wave height and period, 1.15 metres and 2.75 seconds respectively.
- d. When tested at load condition 4.2, both the decked vessel and the open boat capsized at exactly the same combination of wave height and period, 1.20 metres and 2.80 seconds respectively. The decked vessel also capsized within the wave height range 1.3 – 3.0 metres whereas the open boat survived within, and at selected wave periods beyond, that range. This can be explained by the different capsize mechanisms of the decked vessel (item 8.b) and the open boat (item 10.b).
- e. In short, steep waves the open boat often exhibited a wet deck, whereby moderate amounts of water landed on it at every wave encounter and at most headings. At the MCA minimum rating of 190 litres per minute, the bilge pump capacity was adequate to disperse the excess flood water and therefore prevent a capsize. If the bilge pump malfunctioned in these ‘marginal’ conditions, it is highly likely that the vessel would have capsized, thus increasing the number of capsize events from 2 to 8 out of 31 runs performed in total.
- f. In long, steep waves and stern quartering seas, the aft bulwark was often overwhelmed by the incoming waves. Had the model been fitted with a shooting opening as per the actual vessel design, the vessel would have been vulnerable to swamping in following seas.
- g. Whilst the model configuration tested is deemed ‘open’ from a regulatory perspective (as it does not have a *continuous watertight weather deck with positive freeboard in all loading conditions*, [11]) and meets the MCA water freeing requirement for *existing* open vessels, it deviates substantially from conventional open boat designs. For this reason, the open boat described in this report was not assessed against the Wolfson Stability Notice and Freeboard Guidance Mark which were derived from, and are therefore only applicable to, conventional open boats.
- h. The total capacity of the drainage system fitted to the model tested (Figure 4) is 650 litres at full scale. If the test open boat had a bilge pumping failure, up to 650 litres of flood water would accumulate in the draining system and, therefore, act as water ballast below the deck. Flood water in excess of 650 litres would accumulate above deck and the stability would rapidly deteriorate due to increasingly large free surface effects, resulting in a gradually rising VCG. This scenario is described in Figure 12, showing the vessel’s righting lever curve with full drains (0.65t flood water) and, in addition, variable amounts of water on deck, from 0.5t to 2.0t. The analysis shows that, as water accumulates on deck, the vessel develops an increasing angle of loll (ship unstable when upright).
- i. If the deck drained freely to the bilge rather than to a containment tank and a bilge pumping failure occurred, larger amounts of flood water could accumulate below the deck than in the ‘sump and pump’ case, hence the VCG rise due to the flood water would be less. This is demonstrated by Figures 14 to 17 where the ‘free draining’ GZ curve dominates the ‘sump & pump’ GZ curve at any given level of flood water over the range 1.15 – 2.65 t.

11 RECOMMENDATIONS

- 11.1 The decked vessel capsize mechanism consistently entailed the progressive accumulation of water on deck through the freeing ports. Therefore, further model scale testing is recommended to evaluate the merit of retrofitting non-return flaps to the freeing ports of existing decked fishing vessels with less than 300mm freeboard to improve their survivability in waves.
- 11.2 For the decked vessel tested, short and steep waves as may be encountered in coastal sea states proved just as critical as bigger waves representing further offshore conditions. This challenges the distance from safe haven restrictions imposed by the new Code of Practice on 200 to 300mm freeboard vessels. It is therefore recommended to either support such distance-based restrictions with further evidence or consider their replacement with seastate-based guidance according to the Wolfson Stability Method.
- 11.3 At the combinations of regular waves and load condition tested, the decked vessel configuration appeared just as vulnerable to capsizing as the 'equivalent' open vessel in short, steep waves representing coastal seastates where inshore fishing boats would typically operate. Therefore, it is recommended that existing decked monohulls whose dimensions and stability characteristics are similar to the 10m vessel tested are not converted to open vessels in order to meet the Code of Practice water freeing requirements. Such vessels should be permitted to demonstrate compliance via an alternative route, for example a residual freeboard assessment in the worst foreseeable operating condition.

12 REFERENCES

- [1] Maritime and Coastguard Agency. Marine Guidance Note 526F ‘Stability guidance for fishing vessels - Wolfson method’, November 2018.
- [2] Willis et al. ‘The human cost of global fishing’, Marine Policy 148, 2023.
- [3] Low Impact Fishers of Europe, <https://lifeplatform.eu>
- [4] Maritime and Coastguard Agency. ‘The Code of Practice for the Safety of Small Fishing Vessels of less than 15m Length Overall’, last updated 19th August 2022.
- [5] Maritime and Coastguard Agency. Marine Guidance Note 503 Amt. No.1 (F) ‘Procedure for Carrying out Small Fishing Vessel Stability Tests’, September 2022.
- [6] Maritime and Coastguard Agency. ‘Response to queries on the revised code of practice for the safety of small fishing vessels of less than 15m length overall (2021)’, (<https://www.gov.uk/government/publications/applying-the-code-of-practice-for-the-safety-of-small-fishing-vessels-of-less-than-15m-length-overall/response-to-queries-on-the-revised-code-of-practice-for-the-safety-of-small-fishing-vessels-of-less-than-15m-length-overall-2021--2>), 5 May 2021, date of last access: 10 July 2023.
- [7] Wolfson Unit. ‘MCA Research Project 509: High Speed Craft – Evaluation of Existing Criteria, Final Report’. Report No.1779, Maritime & Coastguard Agency, UK.
- [8] Price, W.G. and Bishop, R.E.D., ‘Probabilistic Theory of Ship Dynamics’, Chapman & Hall Ltd., 1974.
- [9] Deakin, B., ‘Spend Less, Save More (Lives)’, Proc. of the 11th International Conference on the Stability of Ships and Ocean Vehicles (STAB 2012), Athens, Greece, 2012.
- [10] Scarponi, M., ‘Stress Tests on the Wolfson Stability Method for Small Fishing Vessels’. Wolfson Unit Report No. 2857, Lloyd’s Register Foundation Small Grant Final Report Sg4\100045, 2022.
- [11] Maritime and Coastguard Agency. Annex 8 ‘Definitions of Decked and Open Vessels’ to Merchant Shipping Note 1871 Amt. 2 ‘The Code of Practice for the Safety of Small Fishing Vessels of less than 15m Length Overall’, last updated August 2022.

Table 1 Principal Dimensions, Datums and Reference Frame

Length Overall	10.427 m
Length Between Perpendiculars	9.650 m
Beam Overall	3.498 m
Depth Amidships	1.480 m
Horizontal Datum	Fore Perpendicular (FP)
Vertical Datum	USK Amidships
Midships Position	4.825m aft of FP
X axis	+ve forward
Y axis	+ve starboard
Z axis	+ve upwards

Table 2 Water Freeing Arrangements as Decked Vessel

Length / Beam Ratio	2.98
CoP requirement for <i>existing</i> vessels of L/B > 2.5	Para 2.20.5: 4% tot. bulwark area each side
Total bulwark area each side (m ²)	5.266
Required freeing port area, each side (m ²)	0.211
Actual freeing port area, each side (m ²)	0.211

All data at full scale unless otherwise noted

Figure 3 shows a bow quarter view of the decked vessel configuration.



Table 3 Water Freeing Arrangements as Open Vessel

CoP requirement for <i>existing</i> open vessels	Para 2.19.4.2 The drainage area should be at least 2% of the total bulwark area above the sole;
Total bulwark area each side (m ²)	5.266
Required drainage area, each side (m ²)	No less than 0.105
Actual drainage area, each side (m ²)	0.105
Long edge of drainage opening (m)	0.420
Short edge of drainage opening (m)	0.251
Capacity of centreline containment tank (litres)	319
Capacity of each duct (litres)	159
Bilge pump capacity (litres / minute)	190

All data at full scale unless otherwise noted

Figure 4 shows the drainage arrangement installed in the open boat configuration.

Table 4 Decked Vessel Stability Notice and Freeboard Guidance Mark

STABILITY NOTICE				
Name 0 No. M1203 Owner 0 Length 10.43 metres Beam 3.498 metres	Loading & Lifting Guidance	Safety Zone	Minimum Freeboard	Maximum Recommended Seastate
	Good margin of residual freeboard	Good margin of safety	At least 43 cm	
	Loading or lifting reduces minimum freeboard to less than 43 cm	Low level of safety	21 to 43 cm	1.3 metres
	Excessive loading or lifting reduces minimum freeboard to less than 21 cm	Danger of capsize	Less than 21 cm	0.6 metres

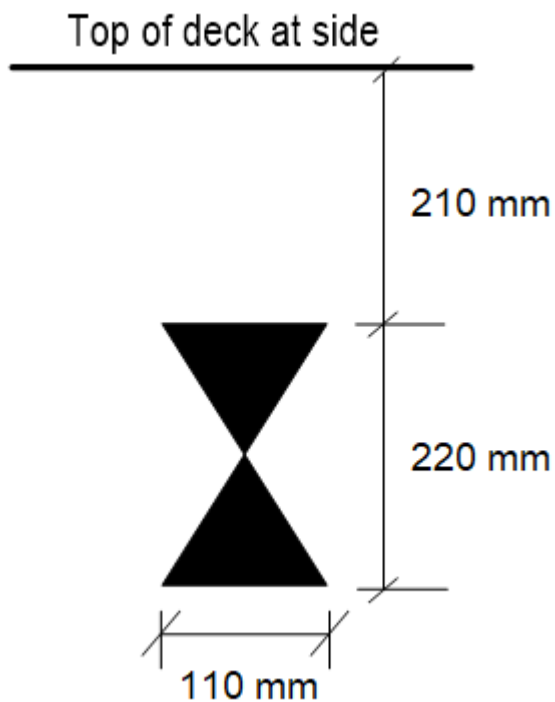



Table 5 Undecked Vessel Stability Notice and Freeboard Guidance Mark

STABILITY NOTICE				
Name 0 No. M1203 Owner 0 Length 10.43 metres Beam 3.498 metres	Loading & Lifting Guidance	Safety Zone	Minimum Freeboard	Maximum Recommended Seastate
	Even with a freeboard of at least 56 cm, swamping may be a hazard	Low level of safety	At least 56 cm	
	Excessive loading or lifting reduces minimum freeboard to less than 56 cm	Danger of capsize	Less than 56 cm	0.6 metres

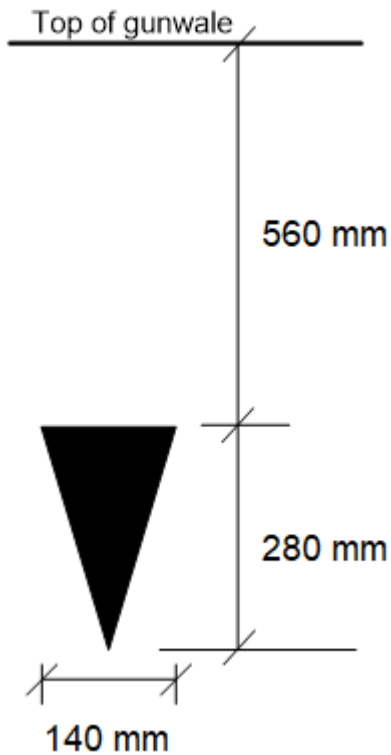

Table 6 Loading Conditions and Configurations

ID	Parent Lightship	Description	Displ.	LCG	VCG fluid	Configurations Calculated	Notes
			tonnes	metres	metres	metres	
LIGHT 0	n/a	As-built (1987) Lightship	10.75	-4.497	1.140	n/a	- unmodified, steel-hulled potter design
LIGHT 1	n/a	Modified (2021) Lightship	11.59	-4.695	1.295	n/a	- re-purposed, heavy gear added above deck - re-ballasted
TEST 0	LIGHT 0	98% Departure Port	12.70	-4.654	1.267	Upright	- as-built departure - passes all CoP New Vessel criteria - fails MGN 503F Offset Load Test - min. upright freeboard: Amber
TEST 1	LIGHT 1	98% Departure Port	13.54	-4.814	1.391	Upright	- modified departure - passes some CoP New Vessel criteria - fails MGN 503F Offset Load Test - min. upright freeboard: Amber
TEST 2	LIGHT 1	10% Arrival Port, Base VCG	14.42	-4.902	1.425	Upright + 4.97° + 9.81°	- catch on deck, empty fish hold - fails most CoP New Vessel criteria - fails MGN 503F Offset Load Test - min. freeboard: Amber (upright) / Red (heeled)
TEST 3	LIGHT 1	10% Arrival Port, High VCG	14.42	-4.902	1.625	Upright + 5.81° + 11.75°	- catch on deck, empty fish hold, top heavy - fails all CoP New Vessel criteria - capsizes at MGN 503F Offset Load Test - min. freeboard: Amber (upright) / Red (heeled)
TEST 4	LIGHT 1	Heavy 10% Arrival Port, High VCG	17.77	-5.220	1.616	Upright + 5.49° + 8.75°	- overloaded & top heavy - fails all CoP New Vessel criteria - capsizes at MGN 503F Offset Load Test - min. freeboard: Red

Table 7 Summary of Stability and Max KG Criteria

			see: \4200 Seastate allowance Phase 1 (HEIF)\WP2 Stability modelling\10m_potter_Rev14.hst Bulwarks as per M1203 & range up to AVS, as model has no downflooding points											
			TEST 0	TEST 1	TEST 2			TEST 3			TEST 4			
Configuration ID =>			0	1	2.1	2.2	2.3	3.1	3.2	3.3	4.1	4.2	4.3	
Condition Data	Displacement	t	12.698	13.537	14.417	14.417	14.417	14.417	14.417	14.417	17.773	17.773	17.773	
	LCG	m from FP	-4.654	-4.814	-4.902	-4.902	-4.902	-4.902	-4.902	-4.902	-5.220	-5.220	-5.220	
	VCGf	m abv base	1.267	1.391	1.425	1.425	1.425	1.625	1.625	1.625	1.616	1.616	1.616	
	TCG	m	0.000	0.000	0.000	0.044	0.090	0.000	0.033	0.066	0.000	0.027	0.040	
	Draught @ AP	m abv base	1.040	1.137	1.201			1.201			1.467			
	Draught @ FP	m abv base	1.123	1.086	1.086			1.086			1.052			
	Equilibrium Heel Angle	degrees (+ve stbd down)	0.00	0.00	0.00	4.80	9.83	0.00	5.83	11.79	0.00	5.52	8.96	
	Freeboard min.	m from deck edge	0.399	0.365	0.322	0.190	0.052	0.322	0.162	-0.001	0.120	-0.020	-0.112	
	Freeboard min. location	% LOA	54%	44%	35%	44%	44%	35%	44%	44%	9%	17%	17%	
	Pos. Clear Height at Side	m from gunwale	1.073	1.043	1.009	0.866	0.712	1.009	0.835	0.653	0.807	0.662	0.559	
Wolfson Safety Zone	as decked		Am	Am	Am	Rd	Rd	Am	Rd	Rd	Rd	Rd	Rd	
	as undecked		Am	Am	Am	Am	Am	Am	Am	Am	Am	Am	Am	
Trim over LBP	m (-ve by bow)		0.724	0.721	0.115			0.115	0.000	0.000	0.415	0.000	0.000	
Trim angle	deg (-ve by bow)		4.29	4.27	0.68			0.68			2.46			
GZ Data	Downflooding angle	deg to stbd	99.0	36.2	34.5	34.5	34.5	34.8	34.5	34.5	29.3	29.3	29.3	
	Max GZ	m	0.247	0.181	0.157	0.117	0.075	0.085	0.053	0.022	0.044	0.018	0.005	
	Positive Range (ignore df)	deg	86.0	63.6	56.8	48.2	38.1	37.7	28.4	16.5	26.5	15.4	7.8	
	GMs	m	0.674	0.564	0.529			0.329			0.312			
Stability Criteria	1: GZ area to 30°	m.rad	0.055	0.08	0.064	0.057	0.037	0.020	0.030	0.015	0.004	0.013	0.003	0.000
	2: GZ area to 40° or df	m.rad	0.09	0.123	0.093	0.080	0.054	0.030	0.034	0.016	0.004	0.013	0.003	0.000
	3: GZ area 30° to 40° or df	m.rad	0.03	0.043	0.029	0.023	0.017	0.010	0.004	0.001	0.000	0.000	0.000	0.000
	4: Max GZ Angle	deg	25	34.2	25.8	23.9	24.3	25.4	18.7	19.3	19.6	12.3	12.5	12.5
	5: GZmax abv 30°	m	0.2	0.247	0.178	0.150	0.112	0.072	0.050	0.022	-0.007	-0.023	-0.046	-0.057
	6: GMf	m	0.35	0.672	0.563	0.526	0.522	0.513	0.326	0.321	0.302	0.275	0.285	0.149
Wolfson	Hcrit, known stability	m full scale		4.354	2.846	2.443	1.790	1.132	1.193	0.709	0.266	0.670	0.249	0.067
		m 1:6 scale		0.726	0.474	0.407	0.298	0.189	0.199	0.118	0.044	0.112	0.041	0.011
	Hcrit, unknown stability	m full scale		2.548	2.548	2.548	1.274	1.274	2.548	1.274	1.274	1.274	1.274	1.274
		m 1:6 scale		0.425	0.425	0.425	0.212	0.212	0.425	0.212	0.212	0.212	0.212	0.212
MGN 503F Offset Load	Equilibrium heel (Move 2)	deg	15	6.9	7.8	7.8								
	Res. Freeboard (Move 2)	mm	75	178	124	83								
	Equilibrium heel (Move 3)	deg	15	10.0	11.3	11.4								
	Res. Freeboard (Move 3)	mm	75	81	15	-24								

Figure 1 Bow Quarter View of Digital Hull Definition

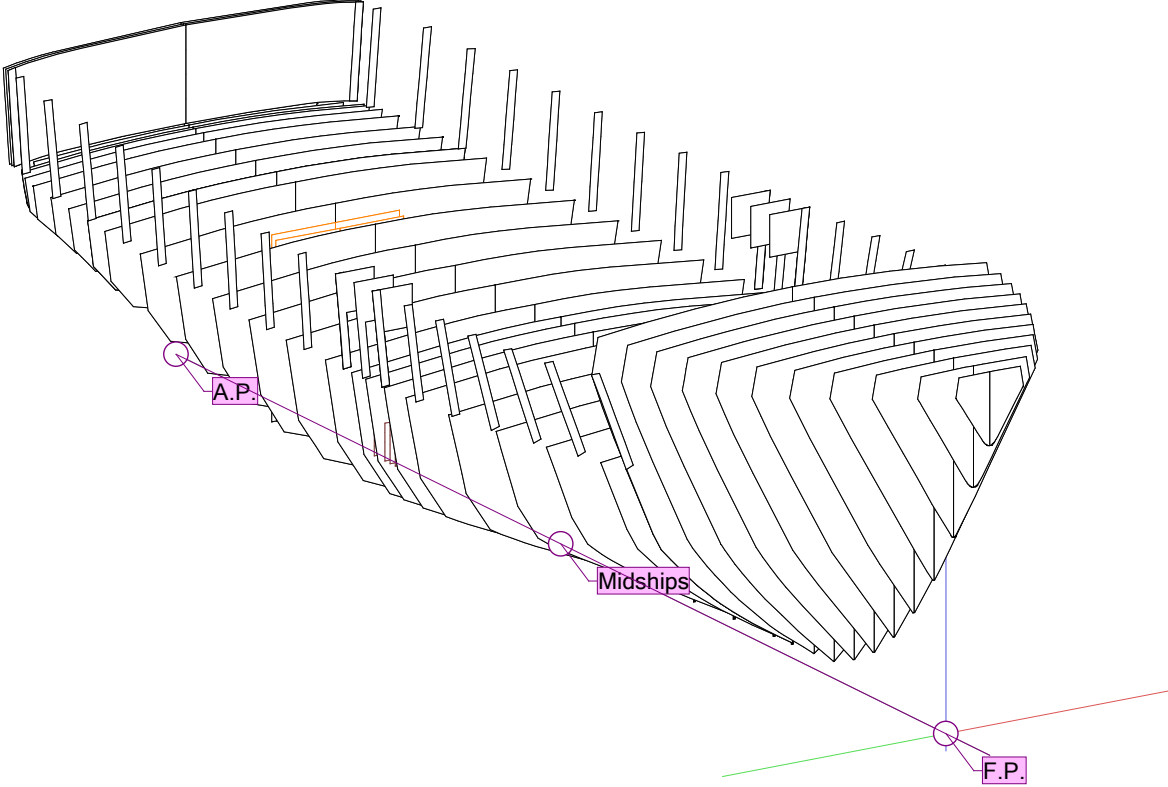

Figure 2 Stern Quarter View of Digital Hull Definition

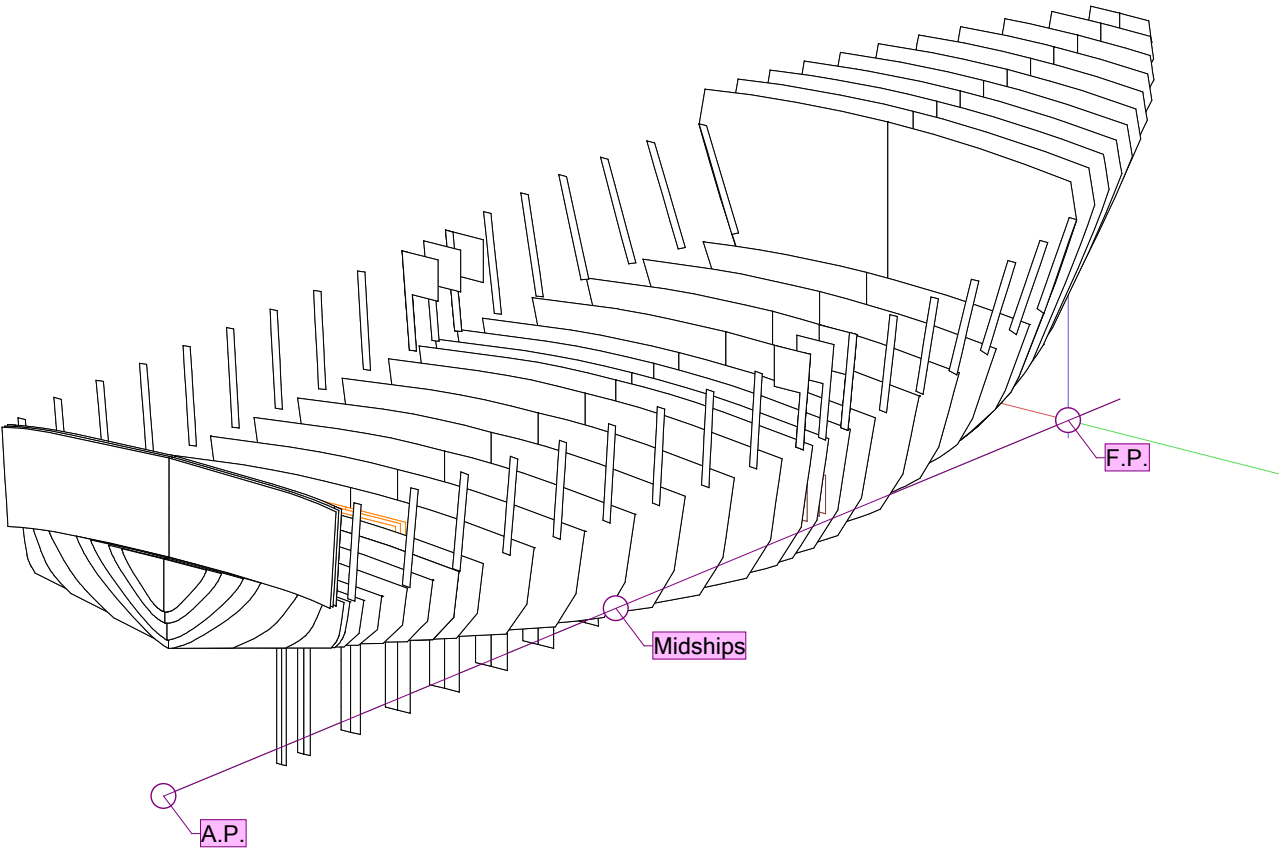

Figure 3 Decked vessel variant under test, 17.77 tonnes displacement, load condition 'TEST 4.2'

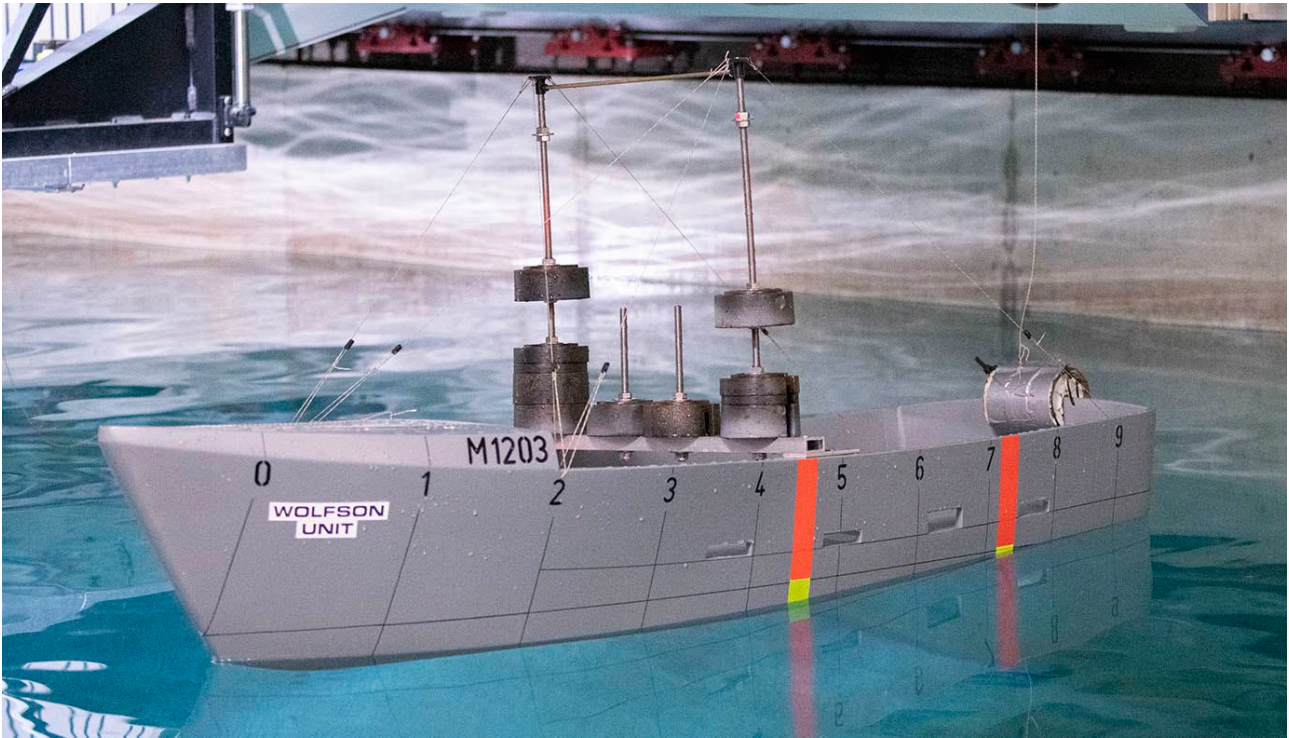

Figure 4 Drainage Arrangement for Open Boat Variant: Detail of Sump and Drain Openings

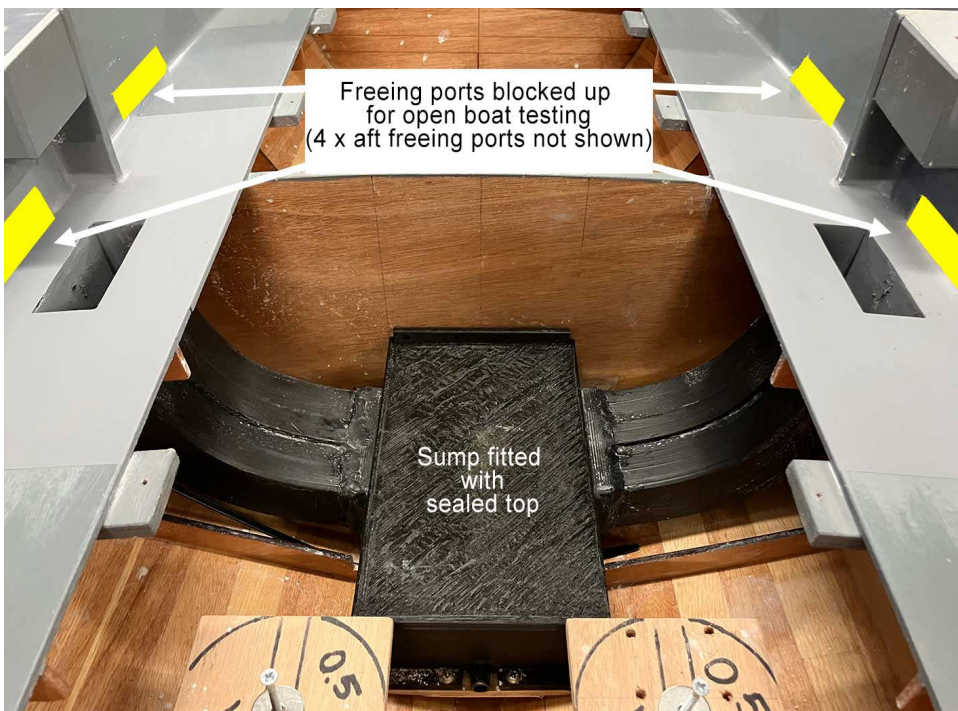
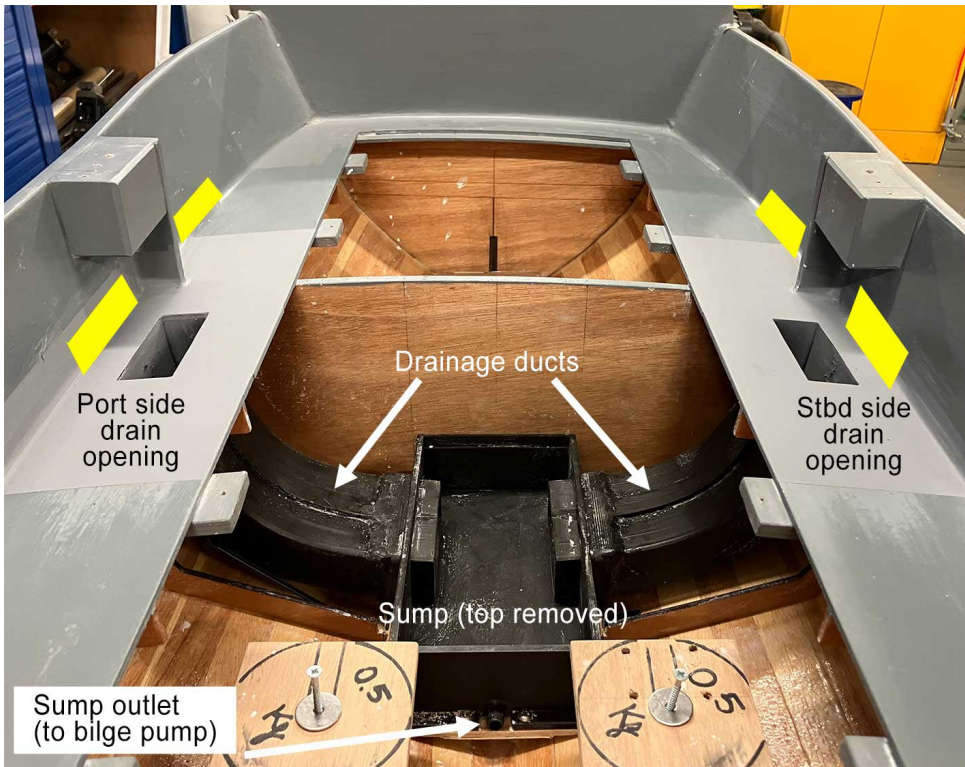

Figure 5 Drainage Arrangement for Open Boat Variant: Details of Bilge Pump Installation



Figure 6 Regular waves measured at loading conditions tested

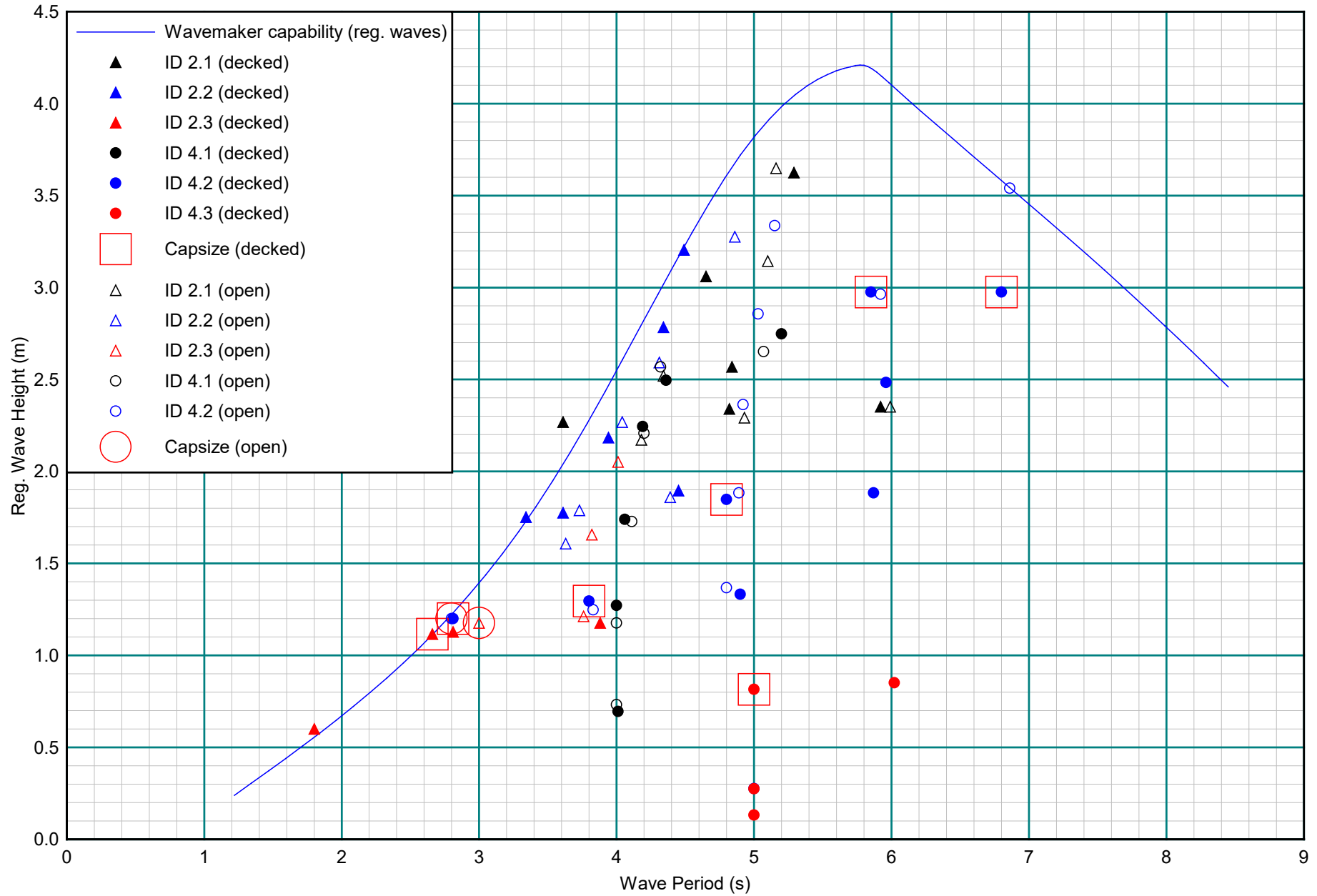

Figure 7a

Capsize boundary for configuration ID 2.1, full scale data

Max. Recommended Regular Wave Height* for decked configuration at 21 to 43cm freeboard = 2.55m
ID 2.1 (decked) freeboard ~32 cm

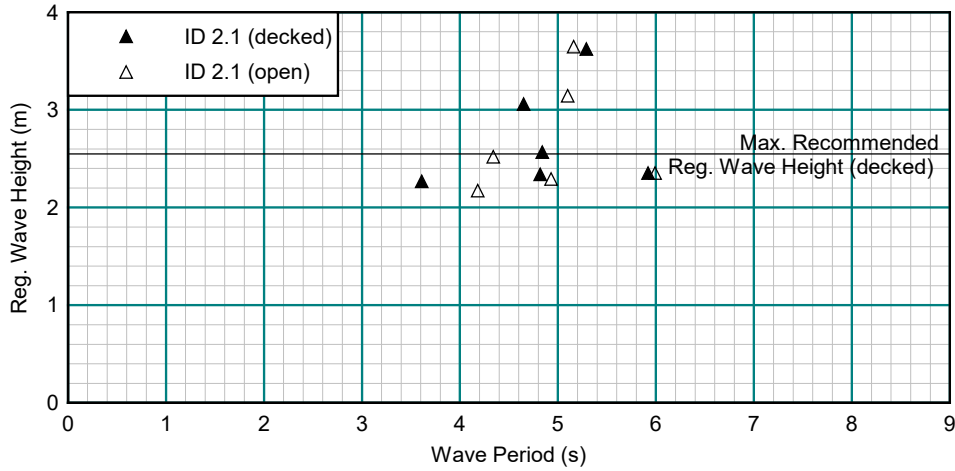

Figure 7b

Capsize boundary for configuration ID 2.2, full scale data

Max. Recommended Regular Wave Height* for decked configuration at < 21cm freeboard = 1.27m
ID 2.2 (decked) freeboard ~19 cm

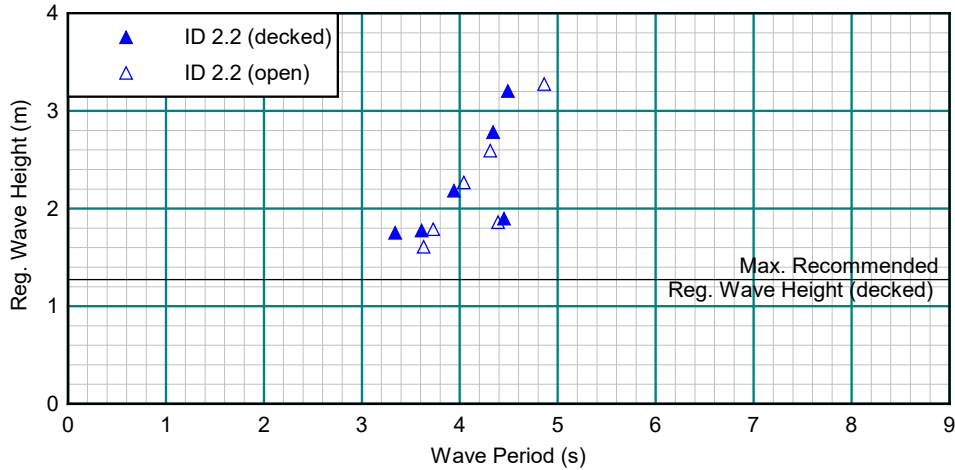
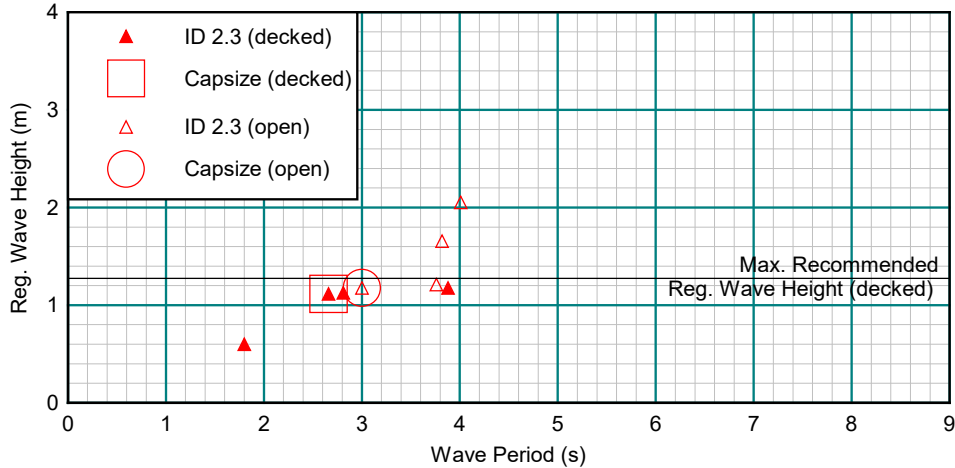

Figure 7c

Capsize boundary for configuration ID 2.3, full scale data

Max. Recommended Regular Wave Height* for decked configuration at < 21cm freeboard = 1.27m
ID 2.3 (decked) freeboard ~5 cm



(*) as predicted by the Wolfson Method

Figure 8a Capsize boundary for configuration ID 4.1, full scale data
Max. Recommended Regular Wave Height* for decked configuration at < 21cm freeboard = 1.27m
ID 4.1 (decked) freeboard ~12 cm

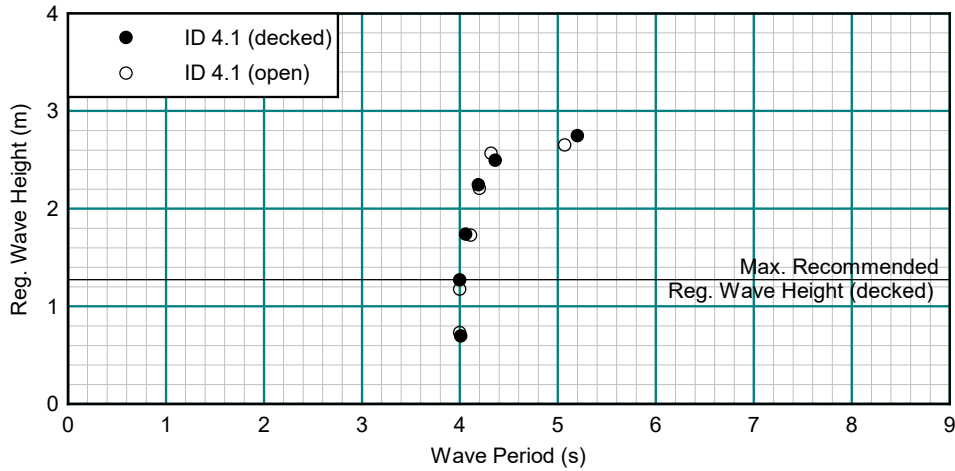

Figure 8b Capsize boundary for configuration ID 4.2, full scale data
Max. Recommended Regular Wave Height* for decked configuration at < 21cm freeboard = 1.27m
ID 4.2 (decked) freeboard ~ -2 cm

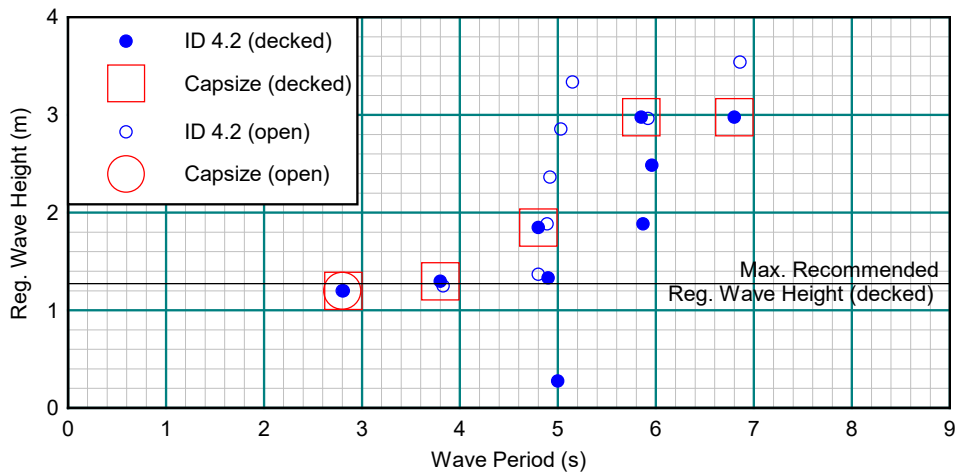
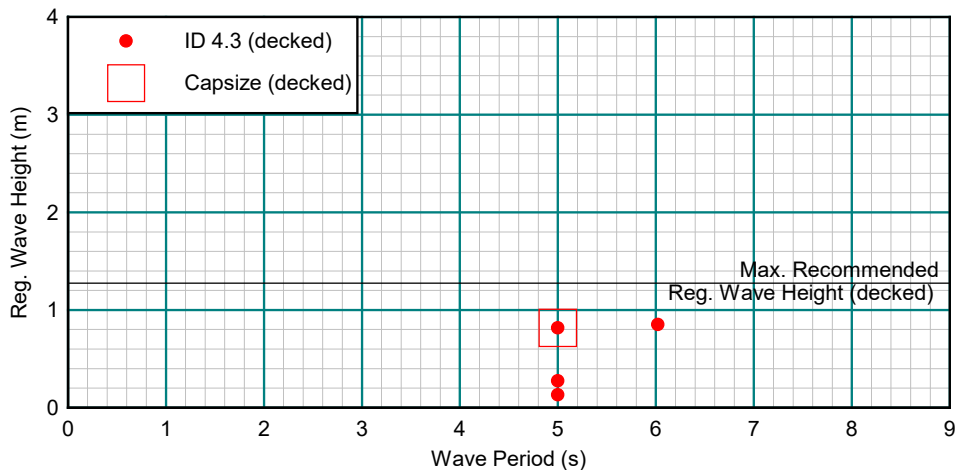

Figure 8c Capsize boundary for configuration ID 4.3, full scale data
Max. Recommended Regular Wave Height* for decked configuration at < 21cm freeboard = 1.27m
ID 4.3 (decked) freeboard ~ -11 cm



(*) as predicted by the Wolfson Method

Figure 9 Decked vessel: relationship between the condition tested and the Wolfson safety zones

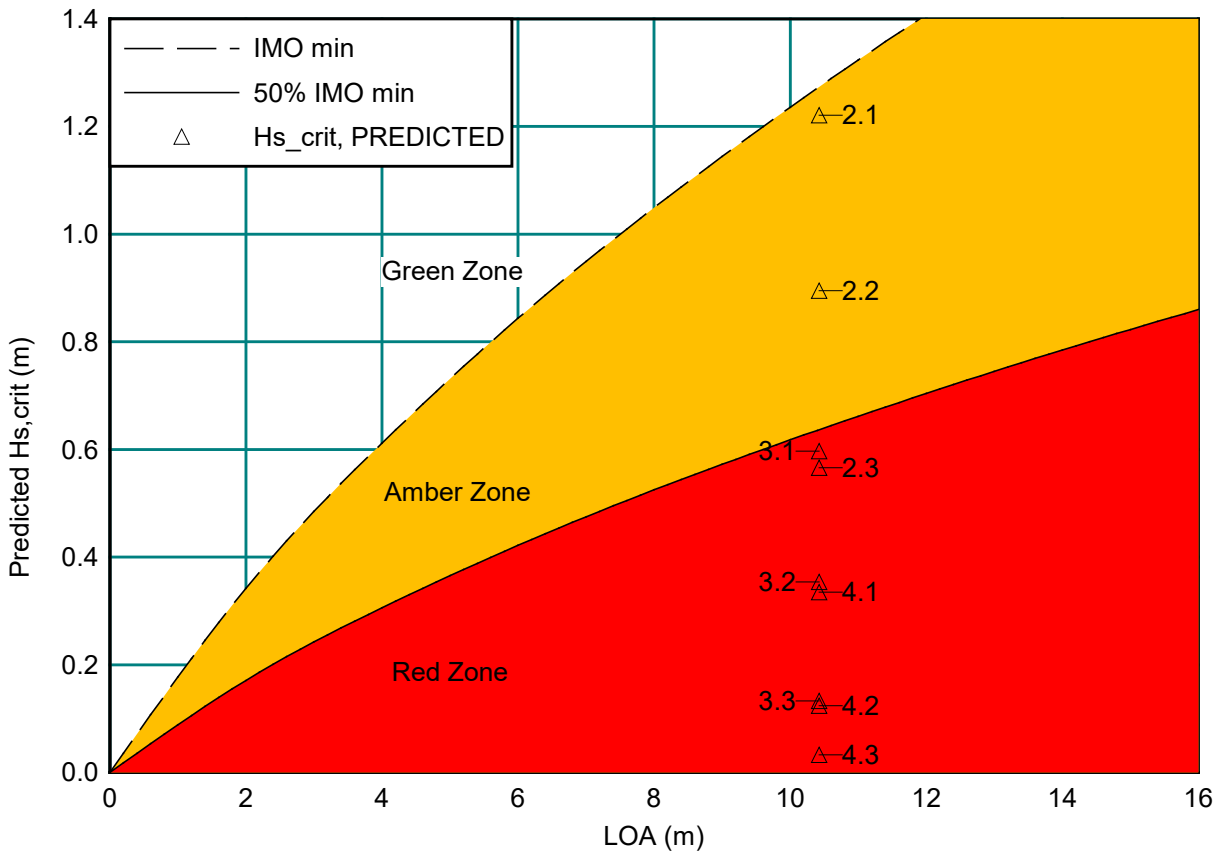

Figure 10 Decked vessel: comparison of predicted critical seastates and actual capsizes wave heights

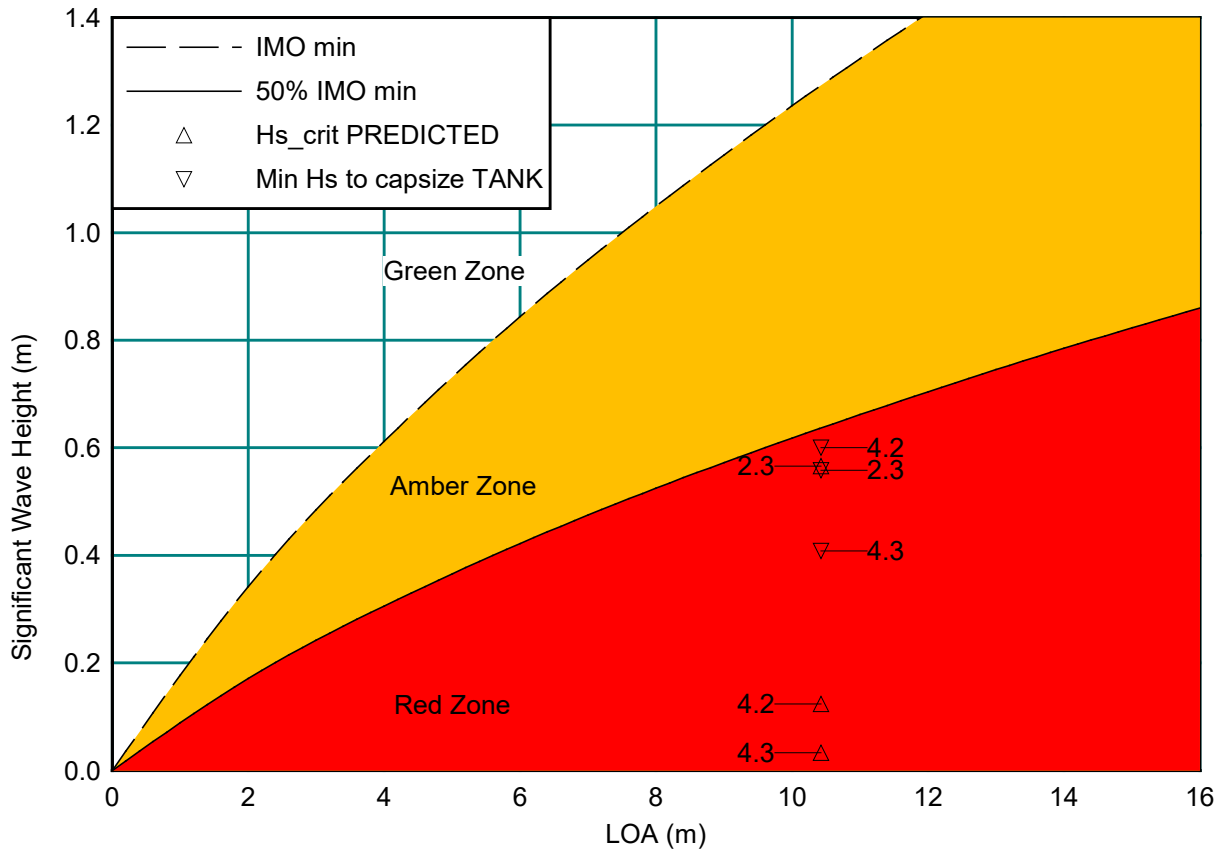

Figure 11 Decked vessel: variation of minimum Wave Height to Capsize / LOA with Stability

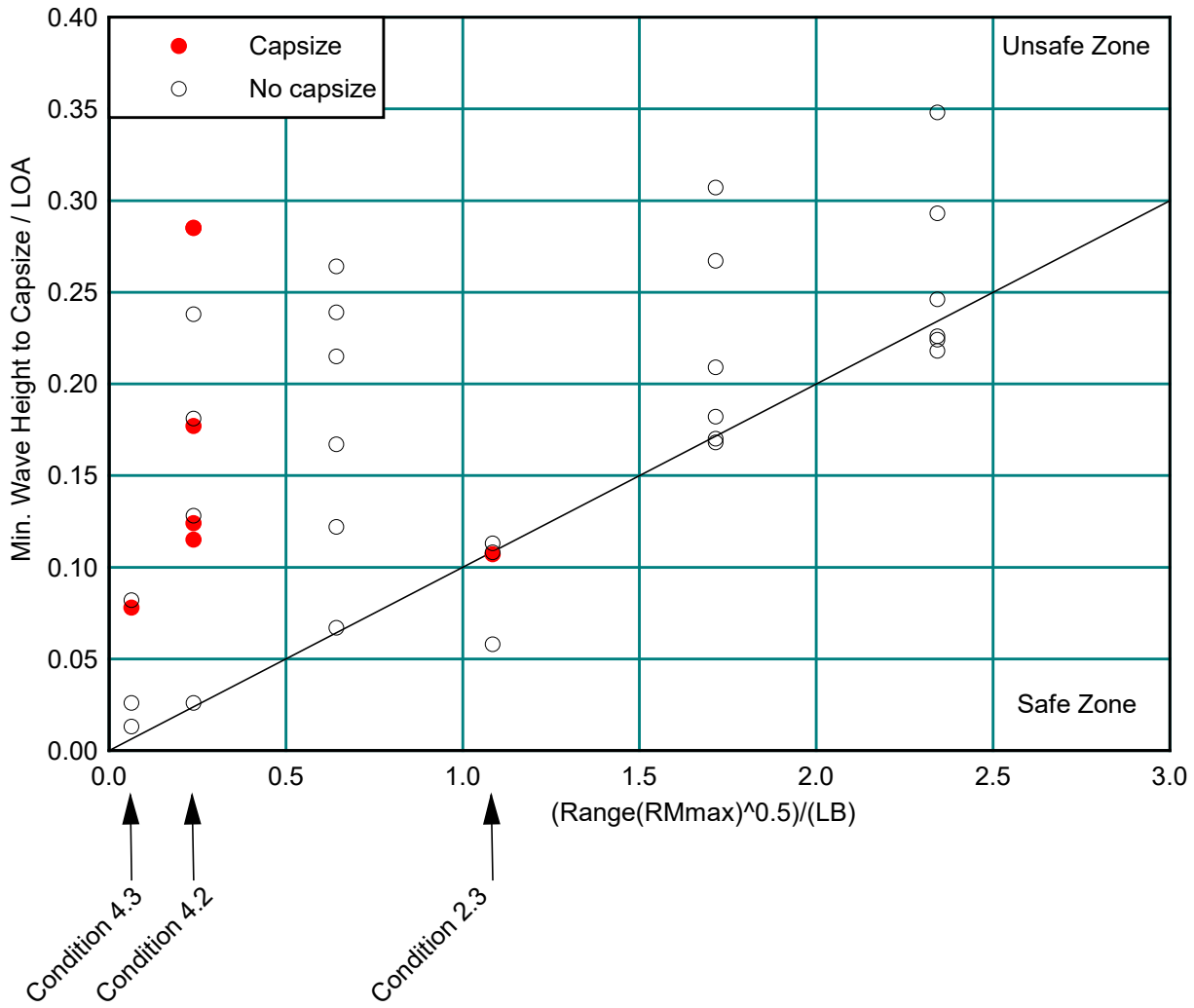

Figure 12 **Open boat variant: Righting Lever (GZ) curves in 'sump & pump' mode**

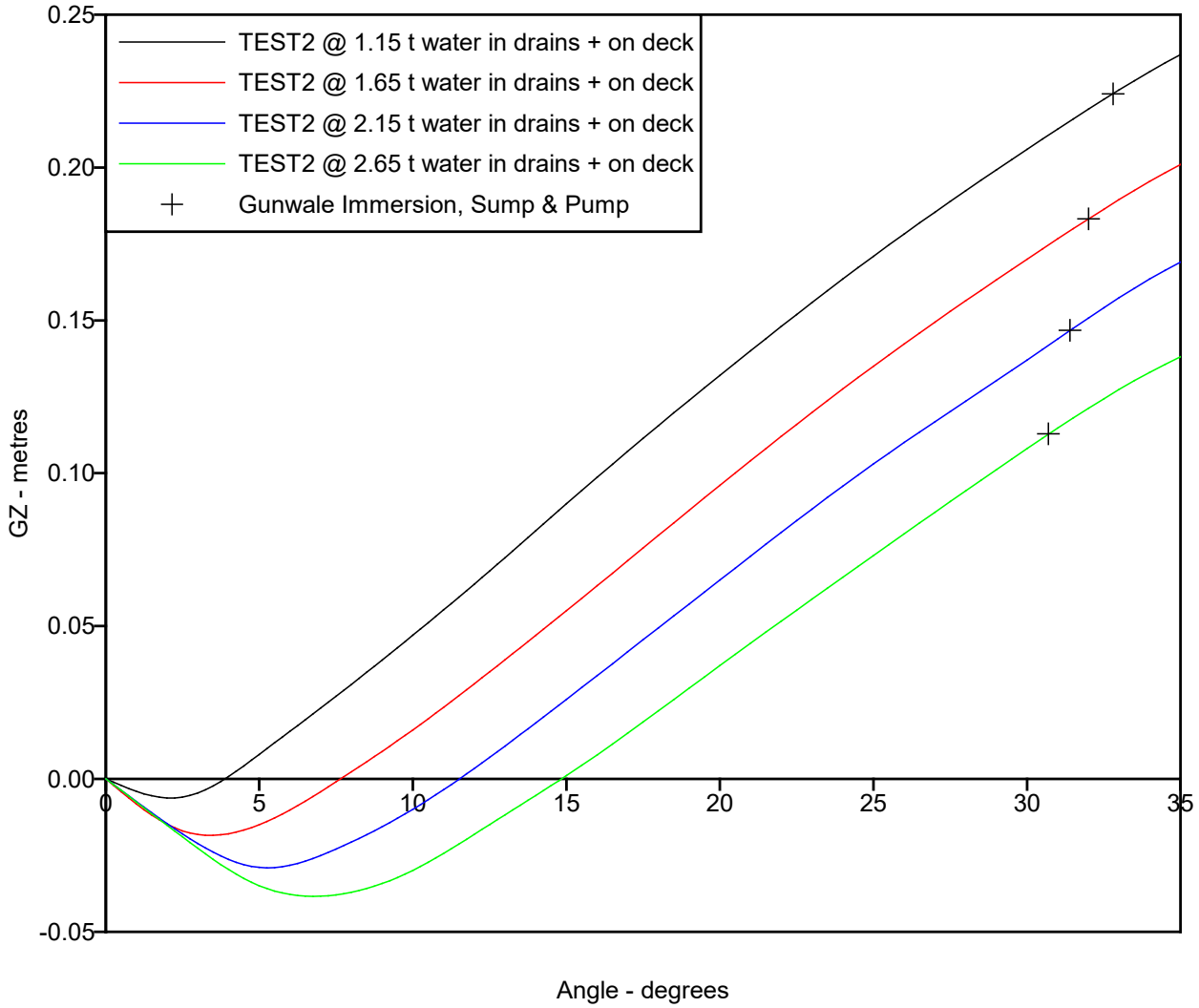

Figure 13 Open boat variant: Righting Lever (GZ) curves in 'free draining to bilge' mode

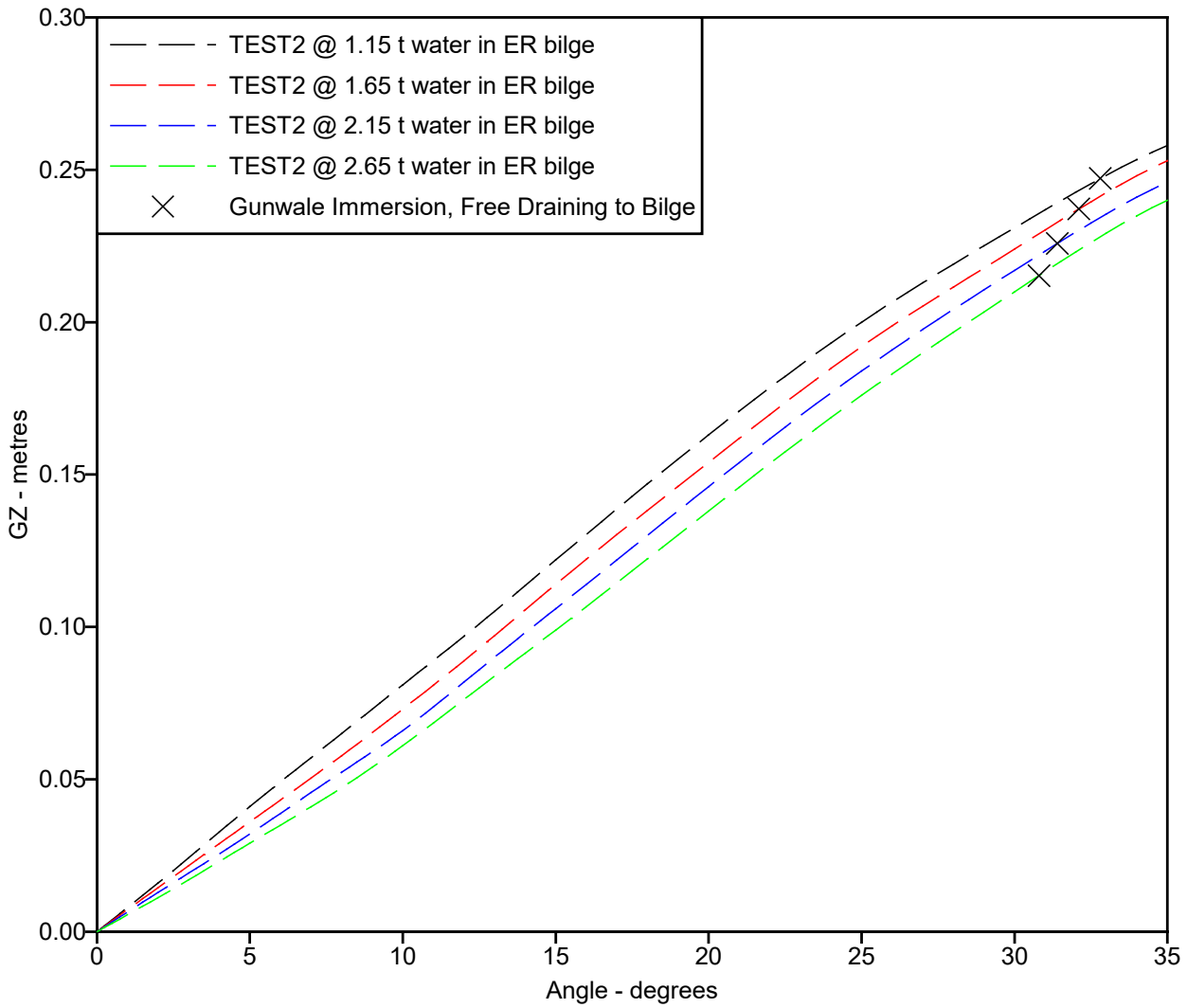

Figure 14 **Open boat variant: Righting Lever (GZ) curves with 1.15 t flood water**

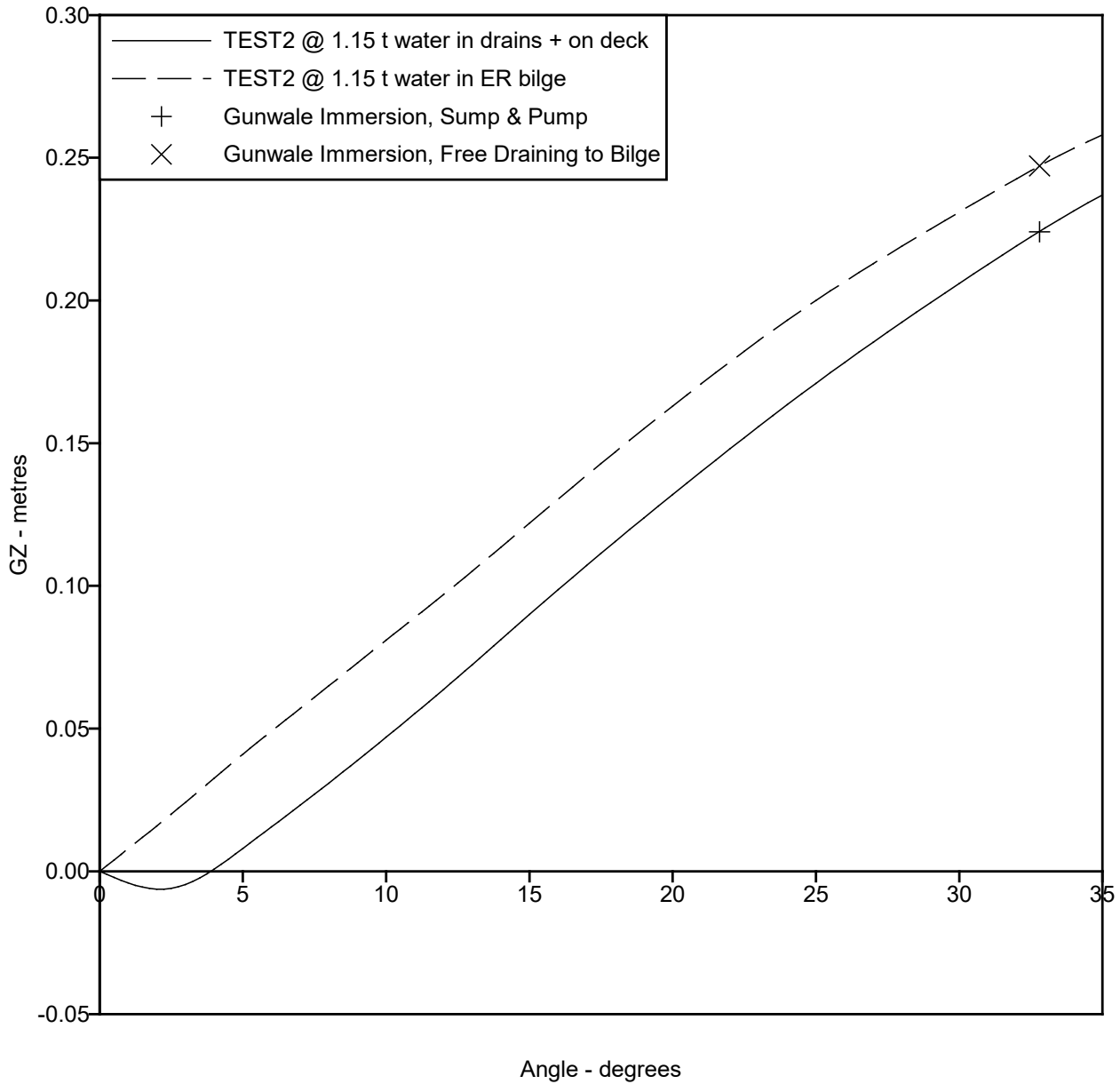

Figure 15 Open boat variant: Righting Lever (GZ) curves with 1.65 t flood water

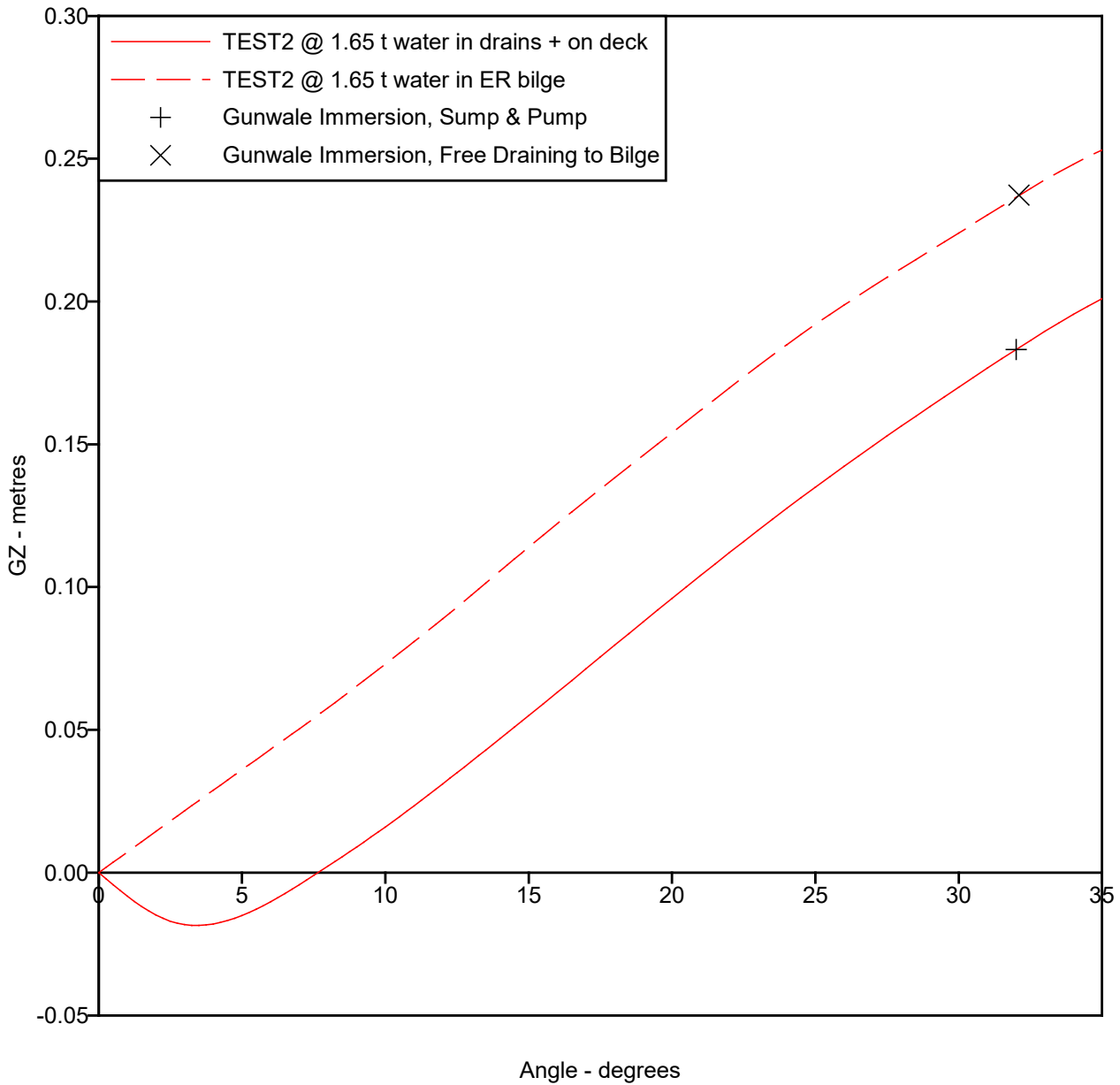

Figure 16 **Open boat variant: Righting Lever (GZ) curves with 2.15 t flood water**

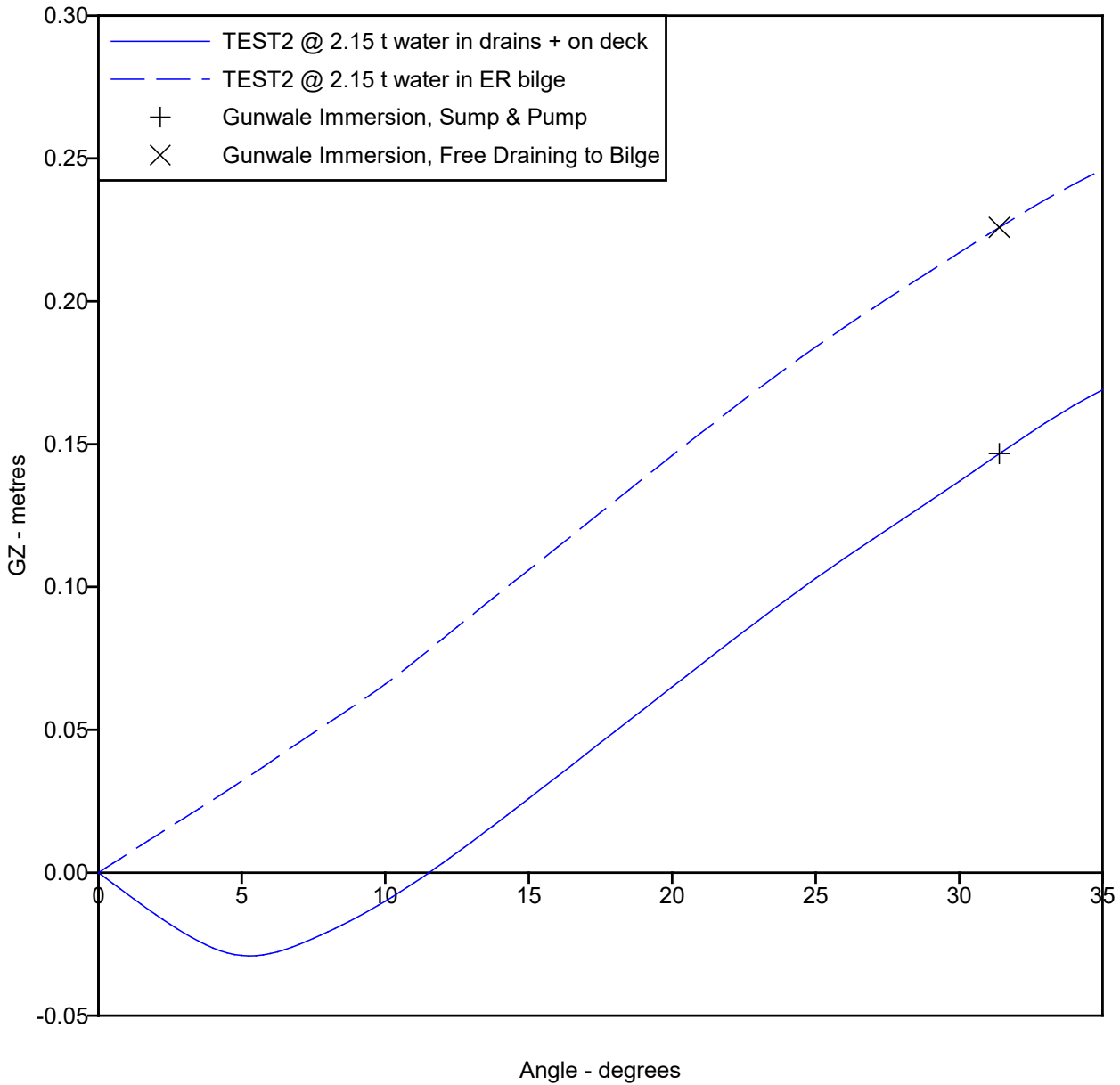

Figure 17 Open boat variant: Righting Lever (GZ) curves with 2.65 t flood water

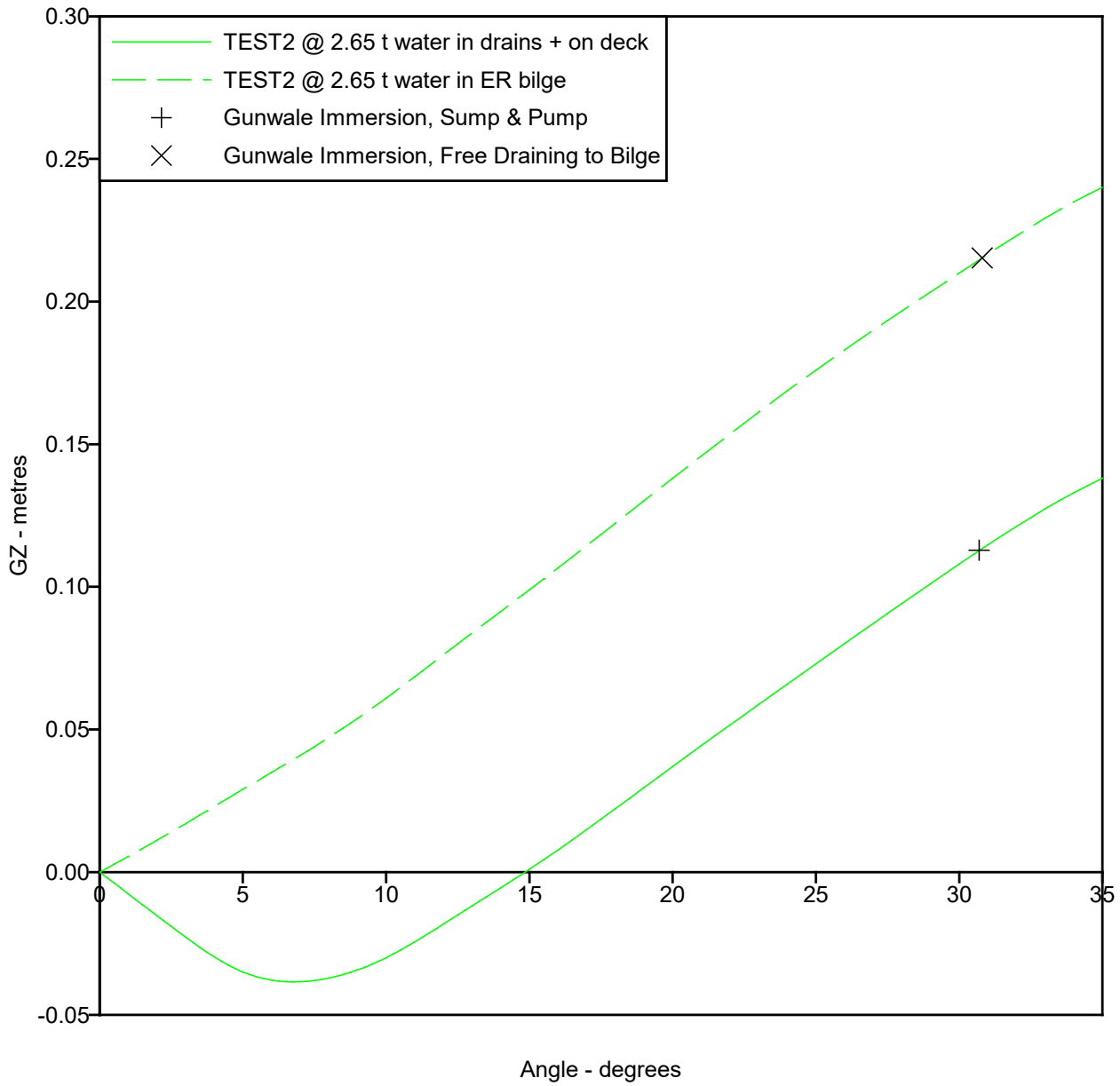

Figure 18 Open boat, loading condition 2.3, run 49: wave height 1.18 metres, wave period 3.0 seconds

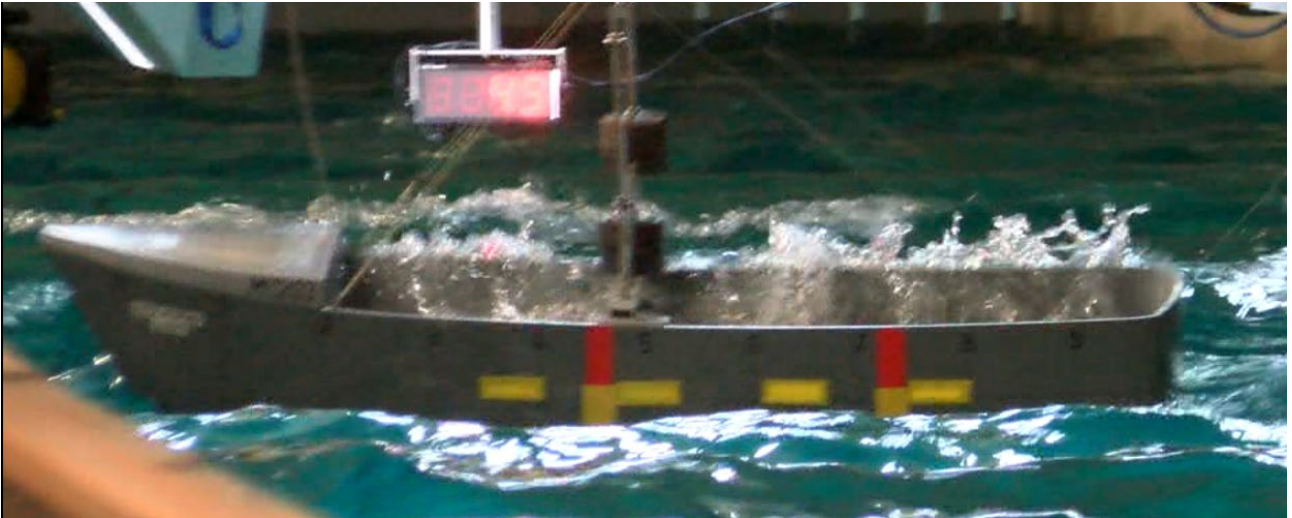

Figure 19 Open boat, loading condition 4.2, run 59: wave height 1.20 metres, wave period 2.8 seconds



Appendix 1 Intact Stability Data

Filename: Z:\Projects\4200 Seastate allowance Phase 1 (HEIF)\WP2 Stability modelling\10m_potter_Rev12.hst

Date : 05/06/2023

Time :08:43:07

Hull

Ship Particulars

Roll Centre	2.000 metres
Specific Gravity of Water	1.0250
Mean Shell Thickness	0.0000 metres
Longitudinal Datum	Fore Perpendicular
Vertical Datum	USK Amidships (X=4.825m)
Trim Length	9.650 metres

Draught Marks	Name	X metres	Z metres
Aft Marks	A.P.	-9.650	0.000
Mid Marks	Midships	-4.825	0.000
Fwd Marks	F.P.	0.000	0.000

Conditions

- 1: TEST 0 Disp: 12.698 tonnes, LCG: -4.654 metres, VCG: 1.267 metres
 - 2: TEST 1 Disp: 13.537 tonnes, LCG: -4.814 metres, VCG: 1.391 metres
 - 3: TEST 2.1 Disp: 14.417 tonnes, LCG: -4.902 metres, VCG: 1.425 metres
 - 4: TEST 2.2 Disp: 14.417 tonnes, LCG: -4.902 metres, VCG: 1.425 metres
 - 5: TEST 2.3 Disp: 14.417 tonnes, LCG: -4.902 metres, VCG: 1.425 metres
 - 6: TEST 3.1 Disp: 14.417 tonnes, LCG: -4.902 metres, VCG: 1.625 metres
 - 7: TEST 3.2 Disp: 14.417 tonnes, LCG: -4.902 metres, VCG: 1.625 metres
 - 8: TEST 3.3 Disp: 14.417 tonnes, LCG: -4.902 metres, VCG: 1.625 metres
 - 9: TEST 4.1 Disp: 17.773 tonnes, LCG: -5.220 metres, VCG: 1.616 metres
 - 10: TEST 4.2 Disp: 17.773 tonnes, LCG: -5.220 metres, VCG: 1.616 metres
 - 11: TEST 4.3 Disp: 17.773 tonnes, LCG: -5.220 metres, VCG: 1.616 metres
-

TEST 0

Displacement	12.698 tonnes
Longitudinal Centre of Gravity	-4.654 metres
Vertical Centre of Gravity	1.267 metres
Transverse Centre of Gravity	0.000 metres
Equilibrium GM	0.672 metres
Equilibrium Heel Angle	0.000 degrees
Equilibrium Draught	1.081 metres
Equilibrium Trim Between Marks	0.083 metres by the bow
Angle of Vanishing Stability	86.0 degrees
Maximum GZ	0.247 metres
Maximum GZ Angle	34.2 degrees

Heel Angle degrees	Righting GZ metres	Lever KN metres	Waterline metres	Trim metres	VCB metres	GZ Curve Area metres.rad
0.0	0.000	0.000	1.123	-0.083	0.737	0.000
5.0	0.059	0.169	1.128	-0.090	0.742	0.003
6.2	0.072	0.209	1.130	-0.094	0.744	0.004
10.0	0.116	0.336	1.141	-0.110	0.755	0.010
12.2	0.140	0.408	1.148	-0.123	0.764	0.015
15.0	0.170	0.498	1.159	-0.140	0.777	0.023
20.0	0.214	0.647	1.185	-0.177	0.805	0.040
25.0	0.237	0.772	1.218	-0.218	0.833	0.059
30.0	0.245	0.879	1.256	-0.253	0.861	0.080
35.0	0.248	0.974	1.292	-0.278	0.892	0.102
40.0	0.239	1.054	1.330	-0.293	0.921	0.123
45.0	0.224	1.120	1.366	-0.290	0.950	0.144
50.0	0.205	1.175	1.399	-0.268	0.979	0.162
55.0	0.180	1.218	1.432	-0.234	1.008	0.179
60.0	0.153	1.250	1.469	-0.195	1.038	0.194

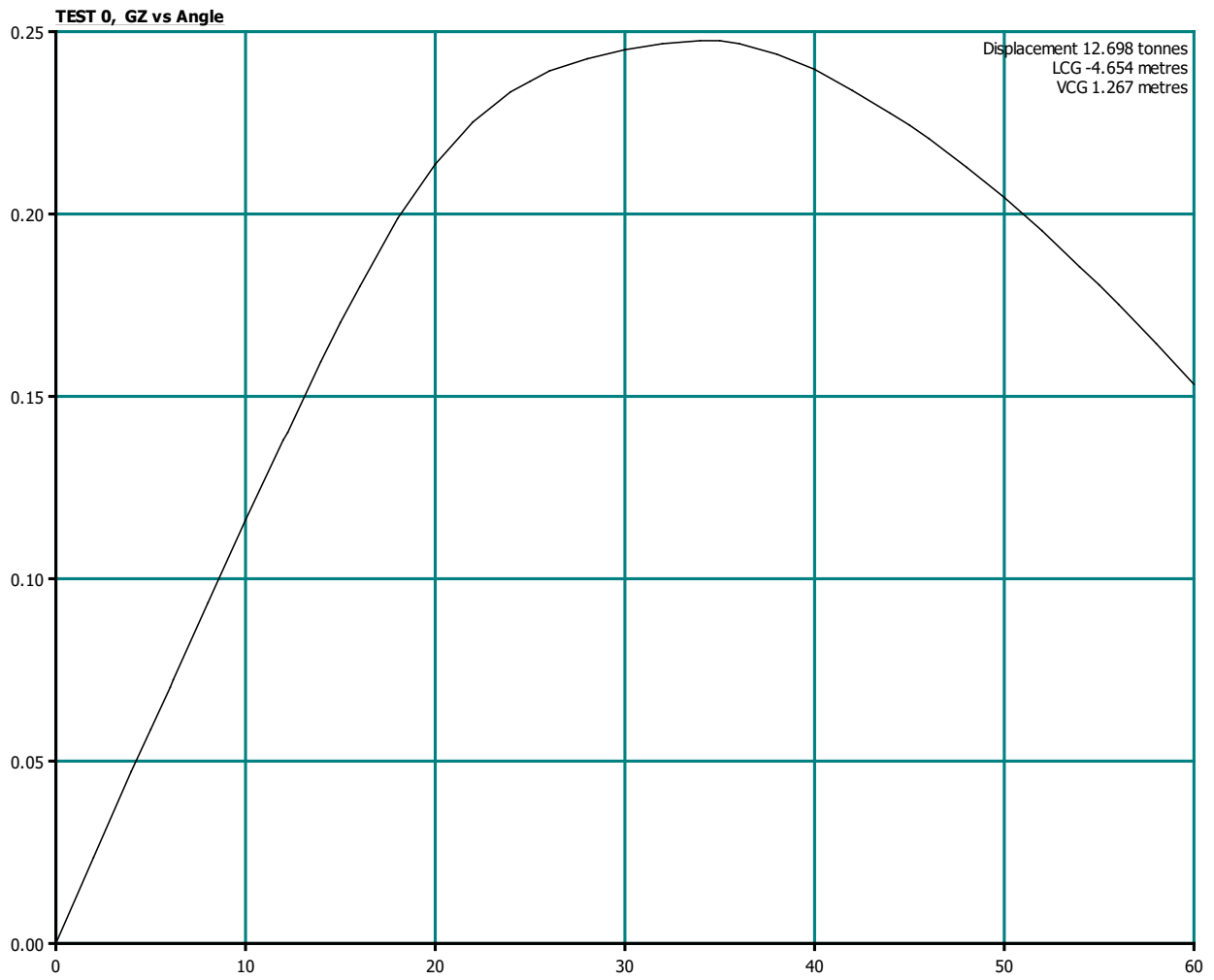

TEST 1

Displacement	13.537 tonnes
Longitudinal Centre of Gravity	-4.814 metres
Vertical Centre of Gravity	1.391 metres
Transverse Centre of Gravity	0.000 metres
Equilibrium GM	0.563 metres
Equilibrium Heel Angle	0.000 degrees
Equilibrium Draught	1.111 metres
Equilibrium Trim Between Marks	0.051 metres by the stern
Angle of Vanishing Stability	63.6 degrees to stbd 63.6 degrees to port
Maximum GZ	0.181 metres to stbd 0.181 metres to port
Maximum GZ Angle	25.8 degrees to stbd 25.8 degrees to port

Heel Angle degrees	Righting GZ metres	Lever KN metres	Waterline metres	Trim metres	VCB metres	GZ Curve Area metres.rad
0.0	0.000	0.000	1.086	0.051	0.759	0.000
5.0	0.049	0.170	1.091	0.044	0.764	0.002
6.2	0.061	0.211	1.093	0.041	0.766	0.003
10.0	0.097	0.338	1.103	0.026	0.777	0.009
12.2	0.117	0.411	1.110	0.016	0.786	0.013
15.0	0.141	0.501	1.120	0.002	0.799	0.019
20.0	0.171	0.647	1.145	-0.027	0.825	0.033
25.0	0.181	0.769	1.177	-0.055	0.851	0.048
30.0	0.178	0.873	1.211	-0.076	0.878	0.064
35.0	0.169	0.967	1.246	-0.088	0.906	0.079
40.0	0.148	1.042	1.284	-0.090	0.931	0.093
45.0	0.121	1.104	1.317	-0.071	0.956	0.105
50.0	0.091	1.157	1.348	-0.037	0.981	0.114
55.0	0.059	1.199	1.381	0.004	1.008	0.121
60.0	0.025	1.230	1.417	0.051	1.035	0.124

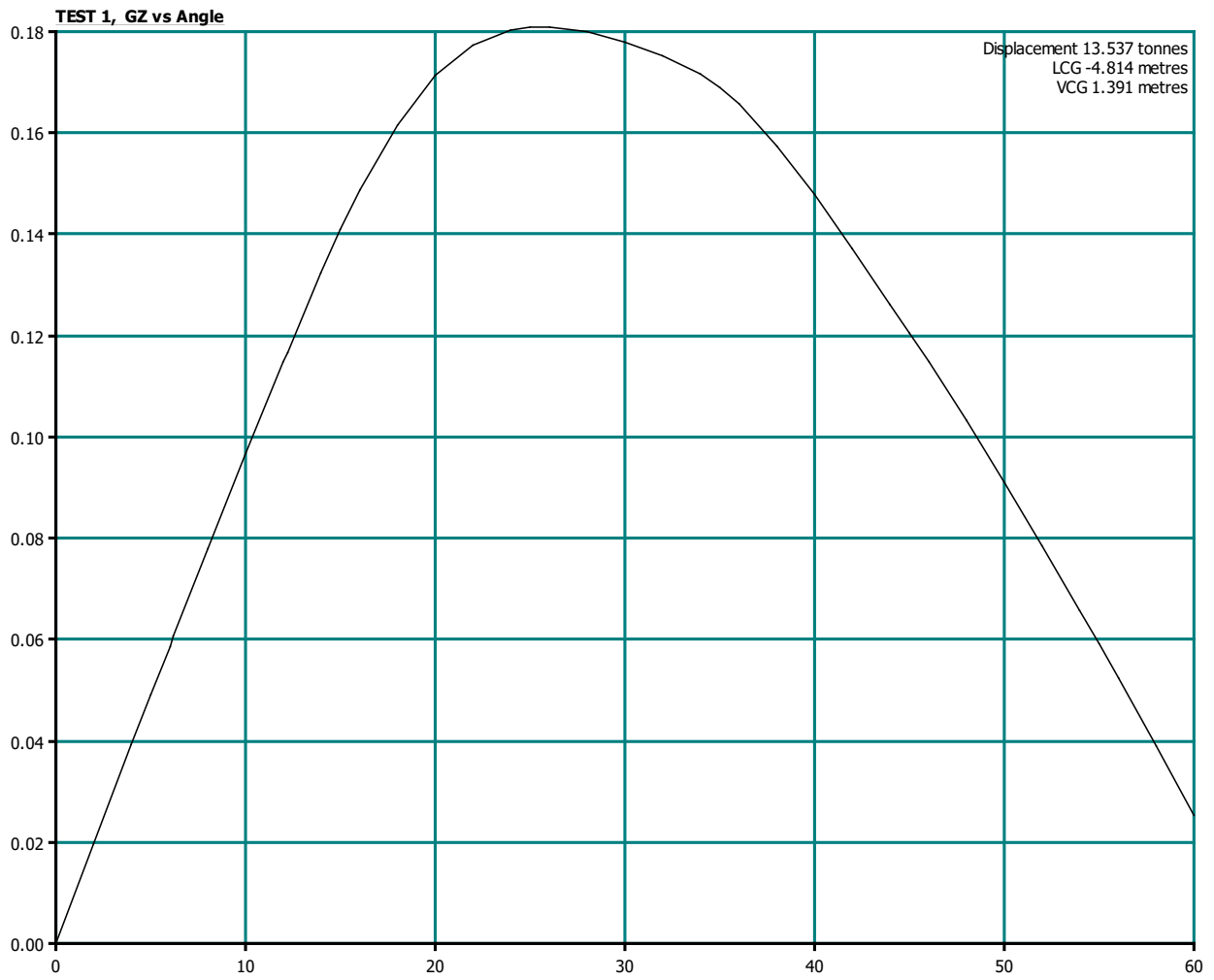

TEST 2.1

Displacement	14.417 tonnes
Longitudinal Centre of Gravity	-4.902 metres
Vertical Centre of Gravity	1.425 metres
Transverse Centre of Gravity	0.000 metres
Equilibrium GM	0.526 metres
Equilibrium Heel Angle	0.000 degrees
Equilibrium Draught	1.144 metres
Equilibrium Trim Between Marks	0.114 metres by the stern
Angle of Vanishing Stability	56.8 degrees to stbd 56.8 degrees to port
Maximum GZ	0.157 metres to stbd 0.157 metres to port
Maximum GZ Angle	23.9 degrees to stbd 23.9 degrees to port

Heel Angle degrees	Righting GZ metres	Lever KN metres	Waterline metres	Trim metres	VCB metres	GZ Curve Area metres.rad
0.0	0.000	0.000	1.087	0.114	0.783	0.000
5.0	0.046	0.170	1.090	0.110	0.787	0.002
6.2	0.056	0.210	1.092	0.107	0.789	0.003
10.0	0.090	0.338	1.101	0.096	0.800	0.008
12.2	0.109	0.410	1.107	0.088	0.809	0.012
15.0	0.130	0.499	1.117	0.077	0.821	0.018
20.0	0.153	0.640	1.140	0.059	0.845	0.030
25.0	0.157	0.759	1.170	0.044	0.869	0.044
30.0	0.150	0.863	1.202	0.036	0.894	0.057
35.0	0.136	0.954	1.236	0.035	0.920	0.070
40.0	0.109	1.025	1.271	0.050	0.941	0.080
45.0	0.079	1.086	1.302	0.082	0.964	0.089
50.0	0.047	1.138	1.332	0.127	0.987	0.094
55.0	0.013	1.180	1.363	0.177	1.011	0.097
60.0	-0.023	1.211	1.398	0.231	1.036	--

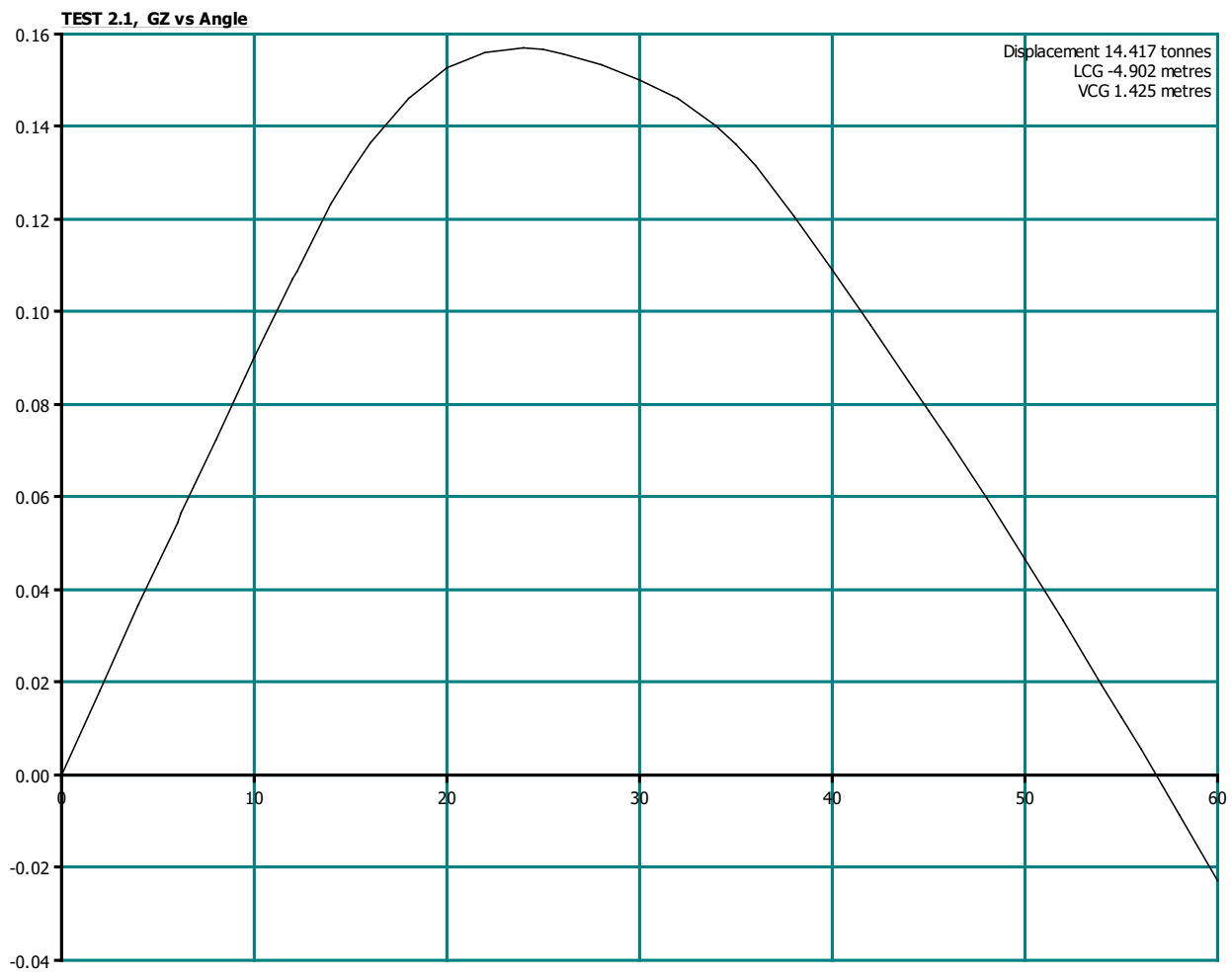

TEST 2.2

Displacement	14.417 tonnes
Longitudinal Centre of Gravity	-4.902 metres
Vertical Centre of Gravity	1.425 metres
Transverse Centre of Gravity	0.044 metres
Equilibrium GM	0.523 metres
Equilibrium Heel Angle	4.803 degrees to stbd
Equilibrium Draught	1.145 metres
Equilibrium Trim Between Marks	0.110 metres by the stern
Angle of Vanishing Stability	53.0 degrees to stbd 59.9 degrees to port
Maximum GZ	0.117 metres to stbd 0.197 metres to port
Maximum GZ Angle	24.3 degrees to stbd 23.4 degrees to port

Heel Angle degrees	Righting GZ metres	Lever KN metres	Waterline metres	Trim metres	VCB metres	GZ Curve Area metres.rad
0.0	-0.044	0.000	1.087	0.114	0.783	0.002
4.8	0.000	0.163	1.090	0.110	0.787	0.000
5.0	0.002	0.170	1.090	0.110	0.787	0.000
6.2	0.013	0.210	1.092	0.107	0.789	0.000
10.0	0.047	0.338	1.101	0.096	0.800	0.002
12.2	0.066	0.410	1.107	0.088	0.809	0.004
15.0	0.088	0.499	1.117	0.077	0.821	0.008
20.0	0.111	0.640	1.140	0.059	0.845	0.017
25.0	0.117	0.759	1.170	0.044	0.869	0.027
30.0	0.112	0.863	1.202	0.036	0.894	0.037
35.0	0.100	0.954	1.236	0.035	0.920	0.046
40.0	0.075	1.025	1.271	0.050	0.941	0.054
45.0	0.048	1.086	1.302	0.082	0.964	0.059
50.0	0.018	1.138	1.332	0.127	0.987	0.062
55.0	-0.013	1.180	1.363	0.177	1.011	--
60.0	-0.045	1.211	1.398	0.231	1.036	--

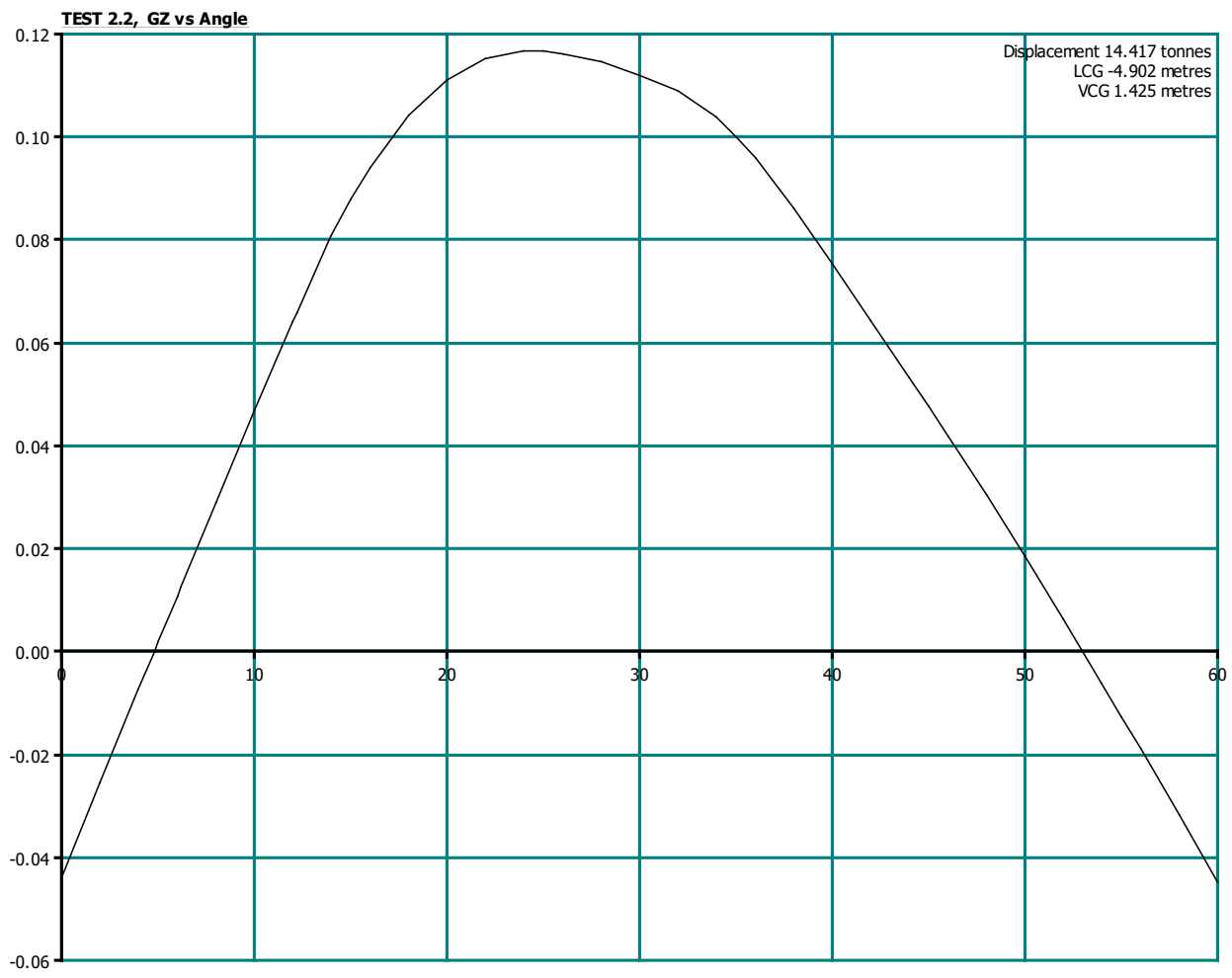

TEST 2.3

Displacement	14.417 tonnes
Longitudinal Centre of Gravity	-4.902 metres
Vertical Centre of Gravity	1.425 metres
Transverse Centre of Gravity	0.090 metres
Equilibrium GM	0.513 metres
Equilibrium Heel Angle	9.833 degrees to stbd
Equilibrium Draught	1.149 metres
Equilibrium Trim Between Marks	0.097 metres by the stern
Angle of Vanishing Stability	47.9 degrees to stbd 62.6 degrees to port
Maximum GZ	0.075 metres to stbd 0.240 metres to port
Maximum GZ Angle	25.4 degrees to stbd 22.6 degrees to port

Heel Angle degrees	Righting GZ metres	Lever KN metres	Waterline metres	Trim metres	VCB metres	GZ Curve Area metres.rad
0.0	-0.090	0.000	1.087	0.114	0.783	0.008
5.0	-0.044	0.170	1.090	0.110	0.787	0.002
6.2	-0.033	0.210	1.092	0.107	0.789	0.001
9.8	0.000	0.332	1.101	0.097	0.800	0.000
10.0	0.002	0.338	1.101	0.096	0.800	0.000
12.2	0.021	0.410	1.107	0.088	0.809	0.000
15.0	0.043	0.499	1.117	0.077	0.821	0.002
20.0	0.068	0.640	1.140	0.059	0.845	0.007
25.0	0.075	0.759	1.170	0.044	0.869	0.013
30.0	0.072	0.863	1.202	0.036	0.894	0.020
35.0	0.062	0.954	1.236	0.035	0.920	0.026
40.0	0.040	1.025	1.271	0.050	0.941	0.030
45.0	0.015	1.086	1.302	0.082	0.964	0.033
50.0	-0.011	1.138	1.332	0.127	0.987	--
55.0	-0.039	1.180	1.363	0.177	1.011	--
60.0	-0.068	1.211	1.398	0.231	1.036	--

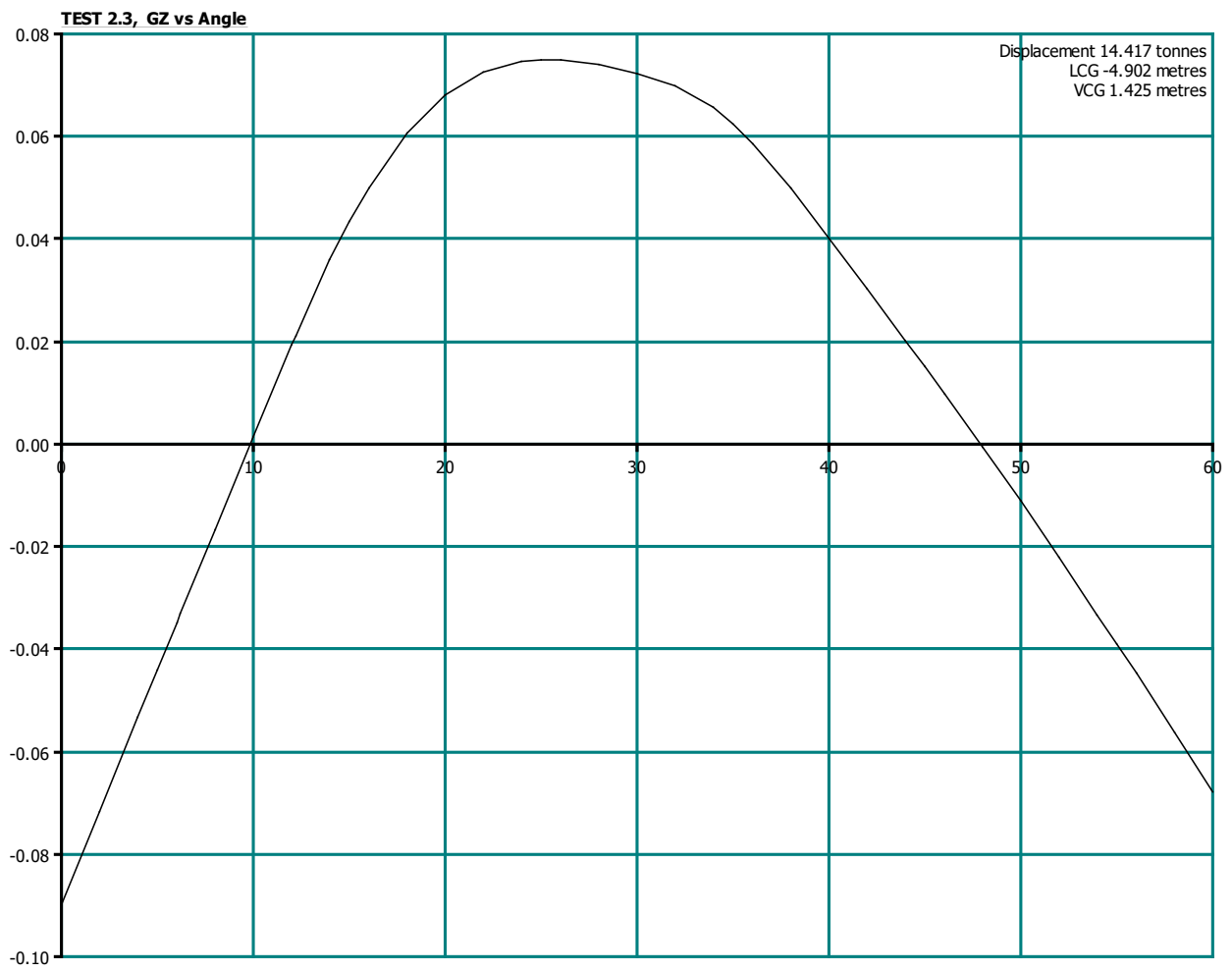

TEST 3.1

Displacement	14.417 tonnes
Longitudinal Centre of Gravity	-4.902 metres
Vertical Centre of Gravity	1.625 metres
Transverse Centre of Gravity	0.000 metres
Equilibrium GM	0.326 metres
Equilibrium Heel Angle	0.000 degrees
Equilibrium Draught	1.144 metres
Equilibrium Trim Between Marks	0.117 metres by the stern
Angle of Vanishing Stability	37.7 degrees
Maximum GZ	0.085 metres
Maximum GZ Angle	18.7 degrees

Heel Angle degrees	Righting GZ metres	Lever KN metres	Waterline metres	Trim metres	VCB metres	GZ Curve Area metres.rad
0.0	0.000	0.000	1.085	0.117	0.783	0.000
5.0	0.028	0.170	1.089	0.112	0.787	0.001
6.2	0.035	0.210	1.091	0.109	0.789	0.002
10.0	0.055	0.338	1.100	0.099	0.800	0.005
12.2	0.067	0.410	1.106	0.090	0.809	0.007
15.0	0.079	0.499	1.116	0.079	0.821	0.011
20.0	0.084	0.640	1.139	0.060	0.845	0.018
25.0	0.072	0.759	1.169	0.046	0.869	0.025
30.0	0.050	0.863	1.202	0.037	0.894	0.030
35.0	0.021	0.954	1.236	0.036	0.920	0.034
40.0	-0.019	1.025	1.270	0.051	0.941	--
45.0	-0.063	1.086	1.301	0.085	0.964	--
50.0	-0.107	1.138	1.330	0.131	0.987	--
55.0	-0.151	1.180	1.361	0.182	1.011	--
60.0	-0.196	1.211	1.395	0.238	1.036	--

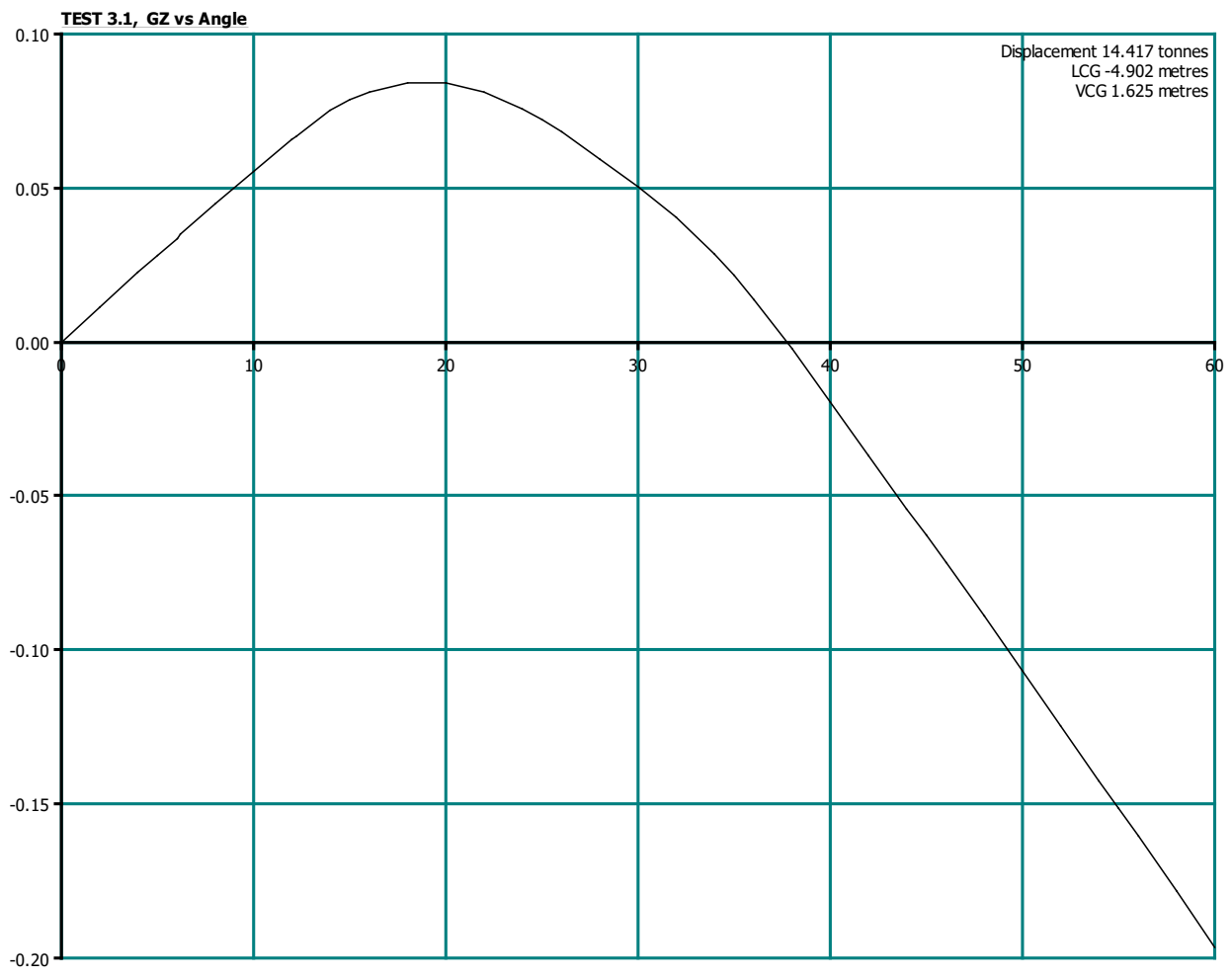

TEST 3.2

Displacement	14.417 tonnes
Longitudinal Centre of Gravity	-4.902 metres
Vertical Centre of Gravity	1.625 metres
Transverse Centre of Gravity	0.033 metres
Equilibrium GM	0.321 metres
Equilibrium Heel Angle	5.828 degrees to stbd
Equilibrium Draught	1.146 metres
Equilibrium Trim Between Marks	0.110 metres by the stern
Angle of Vanishing Stability	34.2 degrees to stbd 40.6 degrees to port
Maximum GZ	0.053 metres to stbd 0.116 metres to port
Maximum GZ Angle	19.3 degrees to stbd 18.5 degrees to port

Heel Angle degrees	Righting GZ metres	Lever KN metres	Waterline metres	Trim metres	VCB metres	GZ Curve Area metres.rad
0.0	-0.033	0.000	1.085	0.117	0.783	0.002
5.0	-0.005	0.170	1.089	0.112	0.787	0.000
5.8	0.000	0.198	1.090	0.110	0.789	0.000
6.2	0.002	0.210	1.091	0.109	0.789	0.000
10.0	0.023	0.338	1.100	0.099	0.800	0.001
12.2	0.034	0.410	1.106	0.090	0.809	0.002
15.0	0.047	0.499	1.116	0.079	0.821	0.004
20.0	0.053	0.640	1.139	0.060	0.845	0.008
25.0	0.042	0.759	1.169	0.046	0.869	0.013
30.0	0.022	0.863	1.202	0.037	0.894	0.015
35.0	-0.006	0.954	1.236	0.036	0.920	--
40.0	-0.045	1.025	1.270	0.051	0.941	--
45.0	-0.086	1.086	1.301	0.085	0.964	--
50.0	-0.128	1.138	1.330	0.131	0.987	--
55.0	-0.170	1.180	1.361	0.182	1.011	--
60.0	-0.213	1.211	1.395	0.238	1.036	--

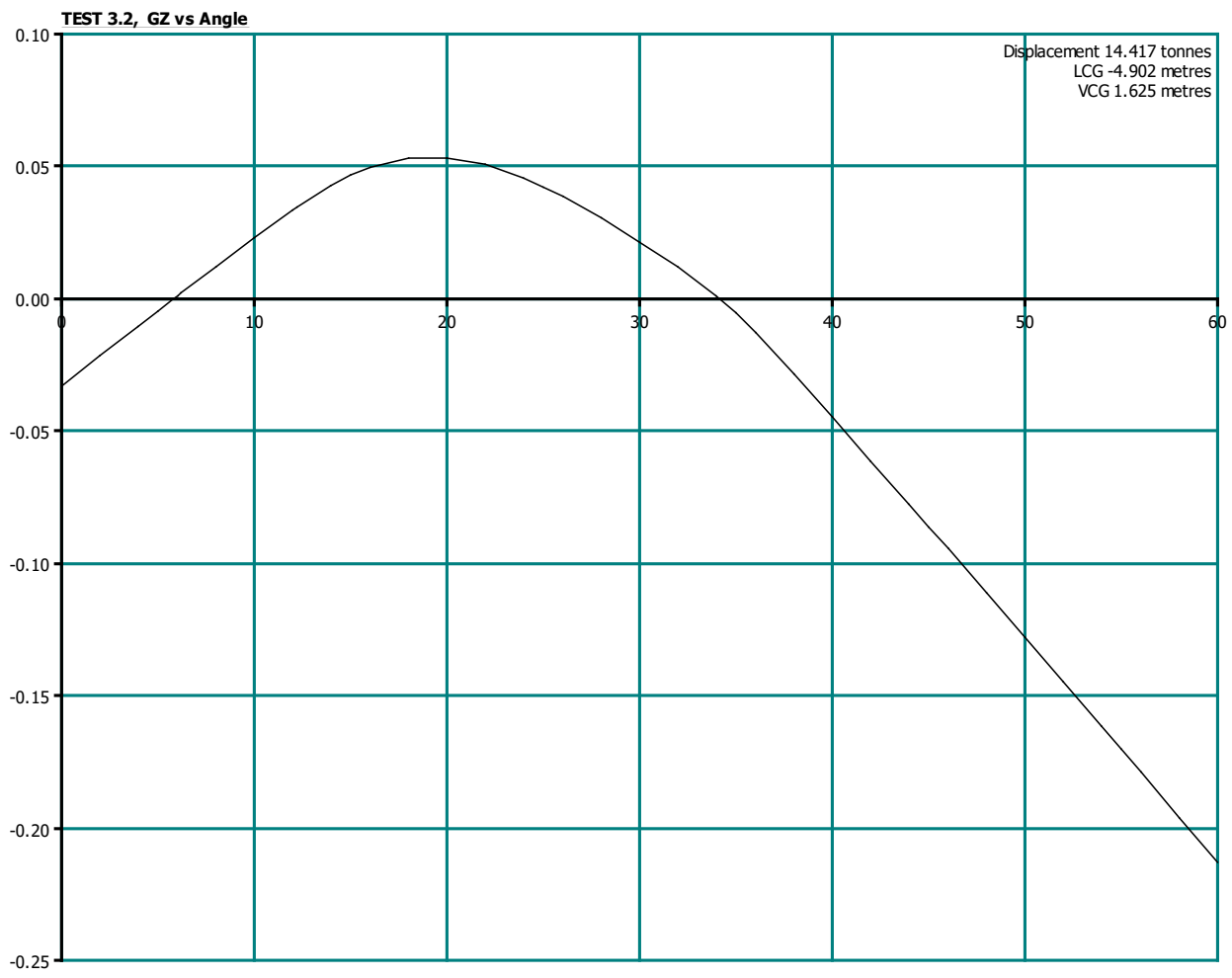

TEST 3.3

Displacement	14.417 tonnes
Longitudinal Centre of Gravity	-4.902 metres
Vertical Centre of Gravity	1.625 metres
Transverse Centre of Gravity	0.066 metres
Equilibrium GM	0.302 metres
Equilibrium Heel Angle	11.788 degrees to stbd
Equilibrium Draught	1.151 metres
Equilibrium Trim Between Marks	0.092 metres by the stern
Angle of Vanishing Stability	28.3 degrees to stbd 43.3 degrees to port
Maximum GZ	0.022 metres to stbd 0.147 metres to port
Maximum GZ Angle	19.6 degrees to stbd 18.3 degrees to port

Heel Angle degrees	Righting GZ metres	Lever KN metres	Waterline metres	Trim metres	VCB metres	GZ Curve Area metres.rad
0.0	-0.066	0.000	1.085	0.117	0.783	0.007
5.0	-0.038	0.170	1.089	0.112	0.787	0.002
6.2	-0.031	0.210	1.091	0.109	0.789	0.002
10.0	-0.010	0.338	1.100	0.099	0.800	0.000
11.8	0.000	0.397	1.105	0.092	0.807	0.000
12.2	0.002	0.410	1.106	0.090	0.809	0.000
15.0	0.015	0.499	1.116	0.079	0.821	0.000
20.0	0.022	0.640	1.139	0.060	0.845	0.002
25.0	0.012	0.759	1.169	0.046	0.869	0.004
30.0	-0.007	0.863	1.202	0.037	0.894	--
35.0	-0.033	0.954	1.236	0.036	0.920	--
40.0	-0.070	1.025	1.270	0.051	0.941	--
45.0	-0.109	1.086	1.301	0.085	0.964	--
50.0	-0.149	1.138	1.330	0.131	0.987	--
55.0	-0.189	1.180	1.361	0.182	1.011	--
60.0	-0.229	1.211	1.395	0.238	1.036	--

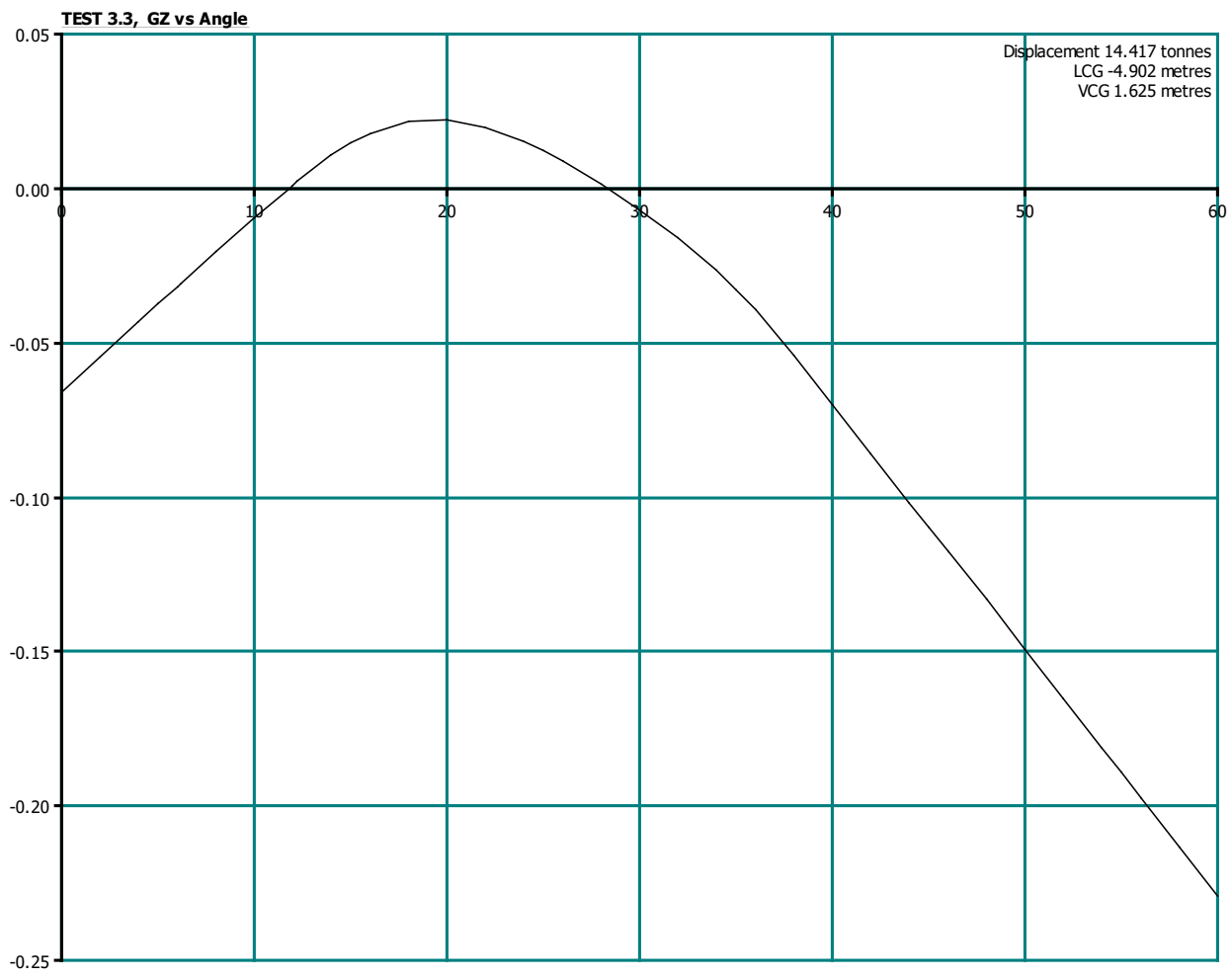

TEST 4.1

Displacement	17.773 tonnes
Longitudinal Centre of Gravity	-5.220 metres
Vertical Centre of Gravity	1.616 metres
Transverse Centre of Gravity	0.000 metres
Equilibrium GM	0.275 metres
Equilibrium Heel Angle	0.000 degrees
Equilibrium Draught	1.259 metres
Equilibrium Trim Between Marks	0.415 metres by the stern
Angle of Vanishing Stability	26.5 degrees to stbd 26.5 degrees to port
Maximum GZ	0.044 metres to stbd 0.044 metres to port
Maximum GZ Angle	12.3 degrees to stbd 12.3 degrees to port

Heel Angle degrees	Righting GZ metres	Lever KN metres	Waterline metres	Trim metres	VCB metres	GZ Curve Area metres.rad
0.0	0.000	0.000	1.052	0.415	0.872	0.000
5.0	0.024	0.165	1.054	0.414	0.876	0.001
6.2	0.030	0.204	1.054	0.414	0.878	0.002
10.0	0.042	0.323	1.054	0.428	0.886	0.004
12.2	0.044	0.386	1.054	0.443	0.892	0.006
15.0	0.042	0.460	1.055	0.467	0.900	0.008
20.0	0.029	0.581	1.062	0.516	0.916	0.011
25.0	0.009	0.692	1.077	0.568	0.934	0.013
30.0	-0.023	0.785	1.091	0.641	0.950	--
35.0	-0.063	0.864	1.111	0.720	0.964	--
40.0	-0.106	0.932	1.131	0.807	0.978	--
45.0	-0.149	0.993	1.150	0.902	0.993	--
50.0	-0.191	1.047	1.170	1.003	1.009	--
55.0	-0.233	1.091	1.192	1.105	1.025	--
60.0	-0.273	1.126	1.219	1.203	1.042	--

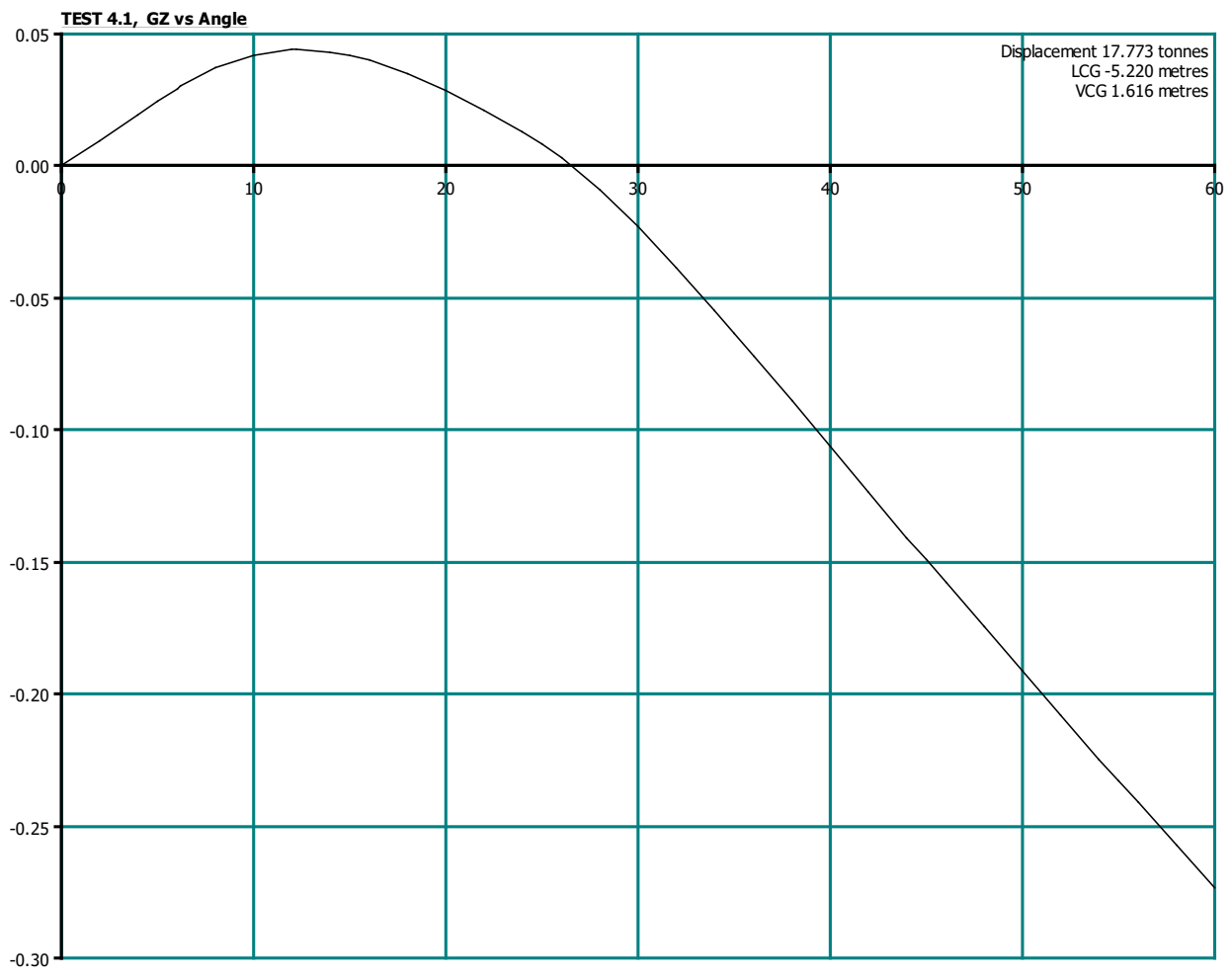

TEST 4.2

Displacement	17.773 tonnes
Longitudinal Centre of Gravity	-5.220 metres
Vertical Centre of Gravity	1.616 metres
Transverse Centre of Gravity	0.027 metres
Equilibrium GM	0.285 metres
Equilibrium Heel Angle	5.518 degrees to stbd
Equilibrium Draught	1.261 metres
Equilibrium Trim Between Marks	0.414 metres by the stern
Angle of Vanishing Stability	20.9 degrees to stbd 30.1 degrees to port
Maximum GZ	0.018 metres to stbd 0.070 metres to port
Maximum GZ Angle	12.5 degrees to stbd 12.2 degrees to port

Heel Angle degrees	Righting GZ metres	Lever KN metres	Waterline metres	Trim metres	VCB metres	GZ Curve Area metres.rad
0.0	-0.027	0.000	1.052	0.415	0.872	0.001
5.0	-0.003	0.165	1.054	0.414	0.876	0.000
5.5	0.000	0.182	1.054	0.414	0.876	0.000
6.2	0.003	0.204	1.054	0.414	0.878	0.000
10.0	0.015	0.323	1.054	0.428	0.886	0.001
12.2	0.018	0.386	1.054	0.443	0.892	0.001
15.0	0.016	0.460	1.055	0.467	0.900	0.002
20.0	0.003	0.581	1.062	0.516	0.916	0.003
25.0	-0.016	0.692	1.077	0.568	0.934	--
30.0	-0.046	0.785	1.091	0.641	0.950	--
35.0	-0.085	0.864	1.111	0.720	0.964	--
40.0	-0.127	0.932	1.131	0.807	0.978	--
45.0	-0.168	0.993	1.150	0.902	0.993	--
50.0	-0.209	1.047	1.170	1.003	1.009	--
55.0	-0.248	1.091	1.192	1.105	1.025	--
60.0	-0.287	1.126	1.219	1.203	1.042	--

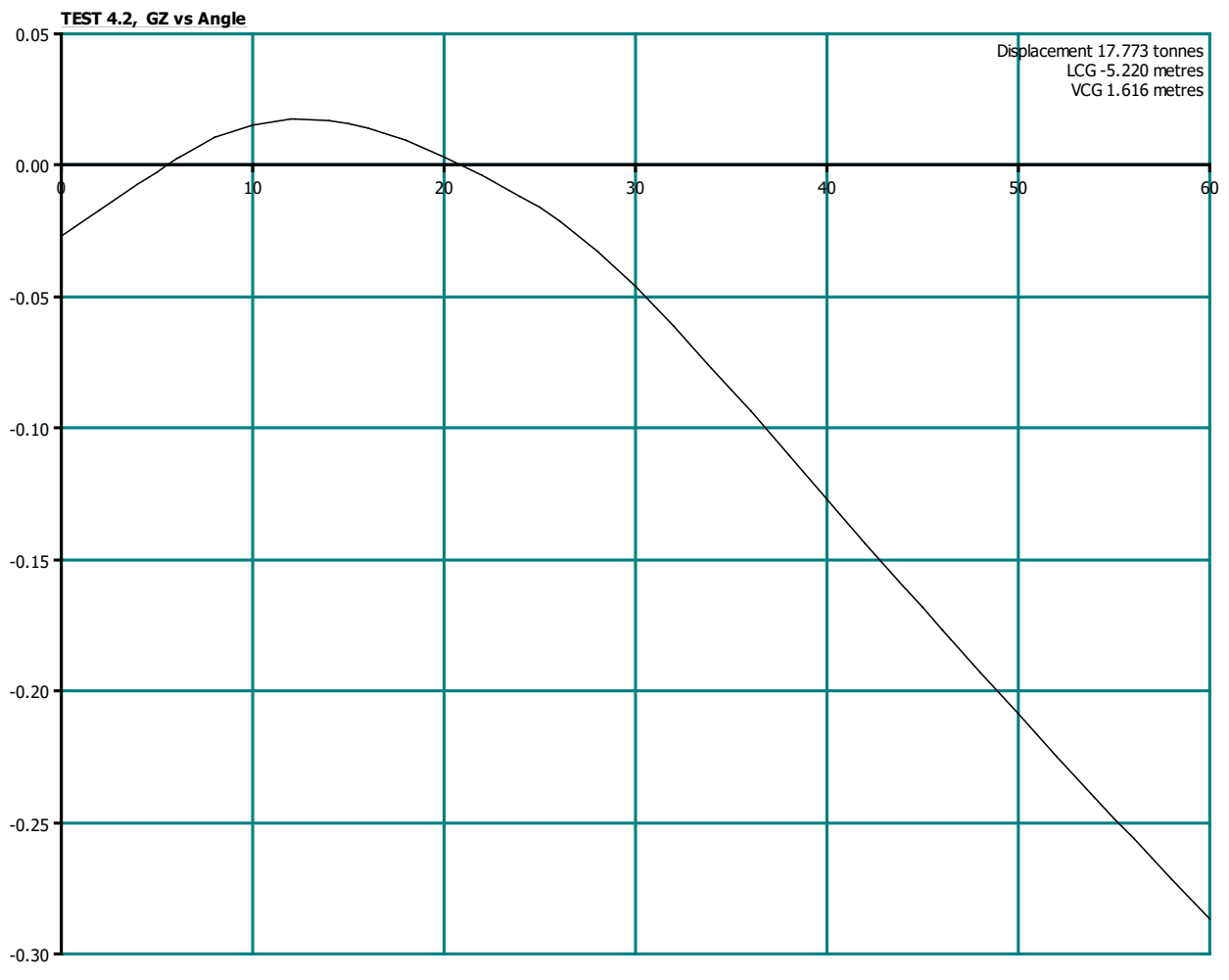

TEST 4.3

Displacement	17.773 tonnes
Longitudinal Centre of Gravity	-5.220 metres
Vertical Centre of Gravity	1.616 metres
Transverse Centre of Gravity	0.040 metres
Equilibrium GM	0.149 metres
Equilibrium Heel Angle	8.961 degrees to stbd
Equilibrium Draught	1.266 metres
Equilibrium Trim Between Marks	0.423 metres by the stern
Angle of Vanishing Stability	16.8 degrees to stbd 31.5 degrees to port
Maximum GZ	0.005 metres to stbd 0.083 metres to port
Maximum GZ Angle	12.5 degrees to stbd 12.2 degrees to port

Heel Angle degrees	Righting GZ metres	Lever KN metres	Waterline metres	Trim metres	VCB metres	GZ Curve Area metres.rad
0.0	-0.040	0.000	1.052	0.415	0.872	0.003
5.0	-0.015	0.165	1.054	0.414	0.876	0.000
6.2	-0.010	0.204	1.054	0.414	0.878	0.000
9.0	0.000	0.292	1.055	0.423	0.884	0.000
10.0	0.003	0.323	1.054	0.428	0.886	0.000
12.2	0.005	0.386	1.054	0.443	0.892	0.000
15.0	0.003	0.460	1.055	0.467	0.900	0.000
20.0	-0.009	0.581	1.062	0.516	0.916	--
25.0	-0.028	0.692	1.077	0.568	0.934	--
30.0	-0.057	0.785	1.091	0.641	0.950	--
35.0	-0.096	0.864	1.111	0.720	0.964	--
40.0	-0.137	0.932	1.131	0.807	0.978	--
45.0	-0.178	0.993	1.150	0.902	0.993	--
50.0	-0.217	1.047	1.170	1.003	1.009	--
55.0	-0.256	1.091	1.192	1.105	1.025	--
60.0	-0.293	1.126	1.219	1.203	1.042	--

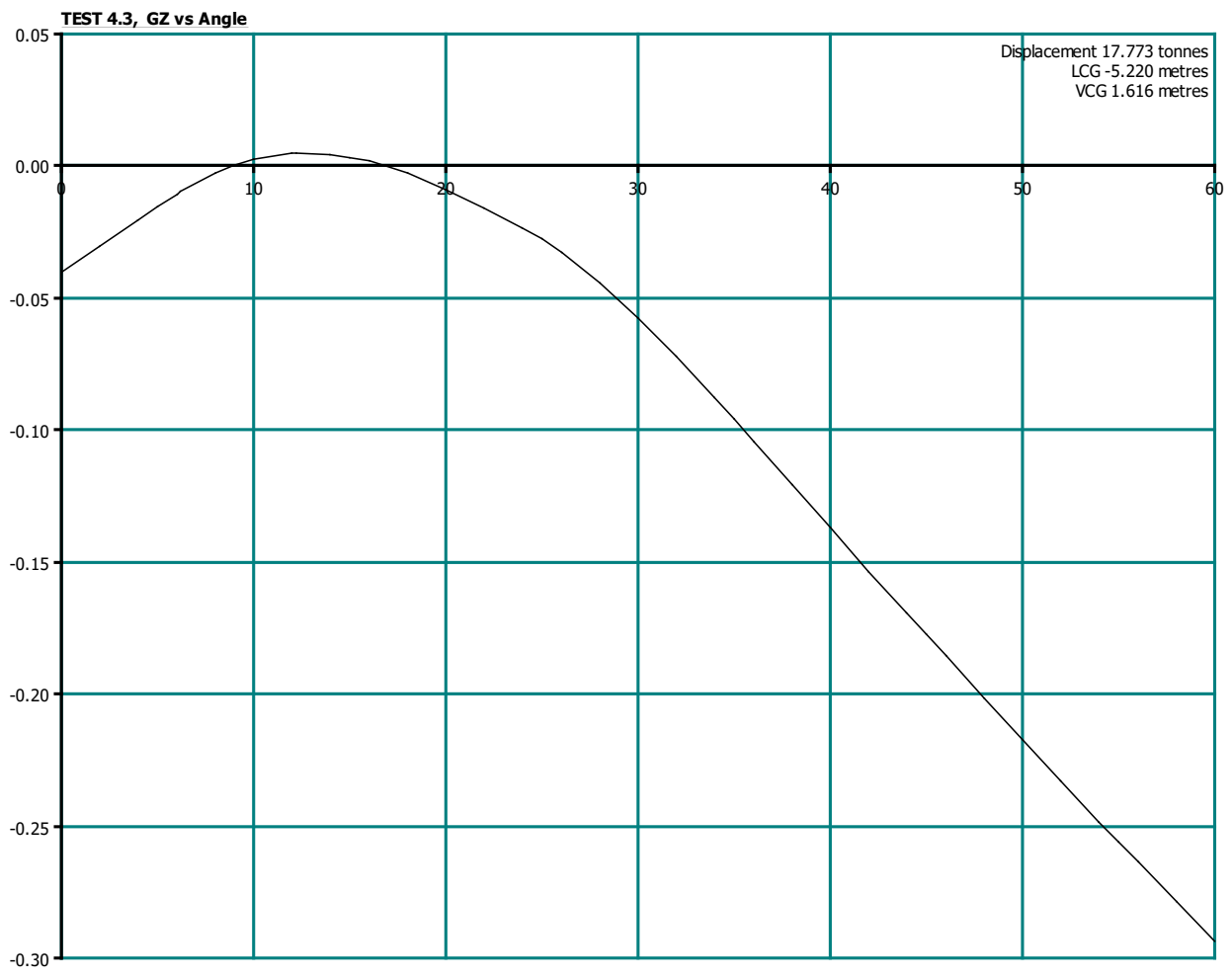



WOLFSON UNIT FOR MARINE TECHNOLOGY AND INDUSTRIAL AERODYNAMICS
UNIVERSITY OF SOUTHAMPTON, BOLDREWOOD INNOVATION CAMPUS
SOUTHAMPTON, UK, SO16 7QF TEL: +44 [0]23 8059 5044 WWW.WUMTIA.COM